

Before using your air conditioner, please read this manual carefully and keep it for future reference.

**INVERTER ONE-TWO / ONE-THREE
/ONE- FOUR/ONE-FIVE SPLIT-TYPE
ROOM AIR CONDITIONER**

INSTALLATION MANUAL

- Please read this installation manual completely before installing the product.
- If the power cord is damaged, replacement work shall be performed by authorised personnel only.
- Installation work must be performed in accordance with the national wiring Standards by authorised personnel only.
- Contact an authorised service technician for repair, maintenance or installation of this unit.

CONTENTS

SAFETY PRECAUTIONS

Warning	2
Caution	2

INSTALLATION INSTRUCTIONS

Selecting installation place.....	3
Wall-mounted type	3
Accessories	4
Four-way cassette type	9
Duct & Ceiling type	15
Ceiling and Floor type	21
Floor and Standing type(Console).....	24
Outdoor unit installation	28

REFRIGERANT PIPE CONNECTION

Refrigerant pipe connection	29
-----------------------------------	----

ELECTRICAL WORK

Electrical work	30
-----------------------	----

AIR PURGING

Air purging with vacuum pump	35
Safety and leakage check	36

TEST RUNNING

Test running	37
--------------------	----

Read This Manual



Inside you will find many helpful hints on how to install and test the air conditioner properly. All the illustrations and specifications in the manual are subject to change without prior notice for product improvement. The actual shape should prevail.

CAUTION

- Contact an authorised service technician for repair or maintenance of this unit.
- The appliance shall be installed in accordance with national wiring regulations.
- This appliance is not intended for use by persons(including children) with reduced physical, sensory or mental capabilities, or lack of experience and knowledge, unless they have been given supervision or instruction concerning use of the appliance by a person responsible for their safety.
- Young children should be supervised to ensure that they do not play with the air conditioner.
- Do not operate your air conditioner in a wet room such as a bathroom or laundry room.
- Installation work must be performed in accordance with the national wiring standards by authorised personnel only.





SAFETY PRECAUTIONS

- Read the follow SAFETY PRECAUTIONS carefully before installation.
- Electrical work must be installed by a licensed electrician. Be sure to use the correct rating of the power plug and main circuit for the model to be installed.
- Incorrect installation due to ignoring of the instruction will cause harm or damage.
 - **The seriousness is classified by the following indications.**

 WARNING	This symbol indicates the possibility of death or serious injury.
 CAUTION	This symbol indicates the possibility of injury or damage to property.

- **The items to be followed are classified by the symbols:**

	Symbol with background white denotes item that is PROHIBITED from doing.
---	--

 WARNING	
1) Engage dealer or specialist for installation. If installation done by the user is defective, it will cause water leakage, electrical shock or fire.	
2) Install according to this installation instructions strictly. If installation is defective, it will cause water leakage, electrical shock or fire.	
3) Use the attached accessories parts and specified parts for installation. otherwise, it will cause the set to fall, water leakage, electrical shock or fire.	
4) Install at a strong and firm location which is able to withstand the set's weight. If the strength is not enough or installation is not properly done, the set will drop and cause injury.	
5) For electrical work, follow the local national wiring standard, regulation and this installation instructions. An independent circuit and single outlet must be used. If electrical circuit capacity is not enough or defect found in electrical work, it will cause electrical shock or fire.	
6) Use the specified cable and connect tightly and clamp the cable so that no external force will be acted on the terminal. If connection or fixing is not perfect, it will cause heat-up or fire at the connection.	
7) Wiring routing must be properly arranged so that control board cover is fixed properly. If control board cover is not fixed perfectly, it will cause heat-up at connection point of terminal, fire or electrical shock.	
8) When carrying out piping connection, take care not to let air substances other than the specified refrigerant go into refrigeration cycle. Otherwise, it will cause lower capacity, abnormal high pressure in the refrigeration cycle, explosion and injury.	
9) Do not modify the length of the power supply cord or use of extension cord, and do not share the single outlet with other electrical appliances. Otherwise, it will cause fire or electrical shock.	
 CAUTION	
1) This equipment must be earthed and installed with earth leakage current breaker. It may cause electrical shock if grounding is not perfect.	
2) Do not install the unit at place where leakage of flammable gas may occur. In case gas leaks and accumulates at surrounding of the unit, it may cause fire.	
3) Carry out drainage piping as mentioned in installation instructions. If drainage is not perfect, water may enter the room and damage the furniture.	
4) The appliance shall be installed in accordance with national wiring regulations.	
5) Do not operate your air conditioner in a wet room such as a bathroom or laundry room.	
6) An all-pole disconnection device which has at least 3mm clearances in all poles, and have a leakage current that may exceed 10mA, the residual current device (RCD) having a rated residual operating current not exceeding 30mA, and disconnection must be incorporated in the fixed wiring in accordance with the wiring rules.	

INSTALLATION INSTRUCTIONS

1. Wall-mounted type

Selecting installation place

Read completely, then follow step by step.

Indoor unit

- Do not expose the indoor unit to heat or steam.
- Select a place where there are no obstacles in front or around the unit.
- Make sure that condensation drainage can be conveniently routed away.
- Do not install near a doorway.
- Ensure that the space on the left and right of the unit is more than 12cm.
- Use a stud finder to locate studs to prevent unnecessary damage to the wall.
- The indoor unit should be installed on the wall at a height of 2.3 metres or more from the floor.
- The indoor unit should be installed allowing a minimum clearance of 15cm from the ceiling.
- Any variations in pipe length will/may require adjustment to refrigerant charge.
- There should not be any direct sunlight. Otherwise, the sun will fade the plastic cabinet and affect its appearance. If unavoidable, sunlight prevention should be taken into consideration.

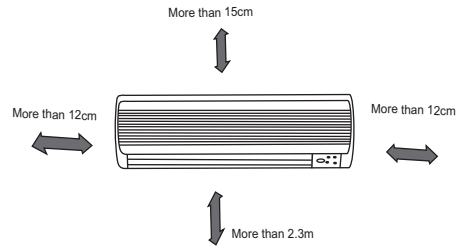

Fig.1

Outdoor unit

- If an awning is built over the outdoor unit to prevent direct sunlight or rain exposure, make sure that heat radiation from the condenser is not restricted.
- Ensure that the clearance around the back of the unit is more than 30cm and left side is more than 30cm. The front of the unit should have more than 200cm of clearance and the connection side (right side) should have more than 60cm of clearance.
- Do not place animals and plants in the path of the air inlet or outlet.
- Take the air conditioner weight into account and select a place where noise and vibration will not be an issue.
- Select a place so that the warm air and noise from the air conditioner do not disturb neighbors.

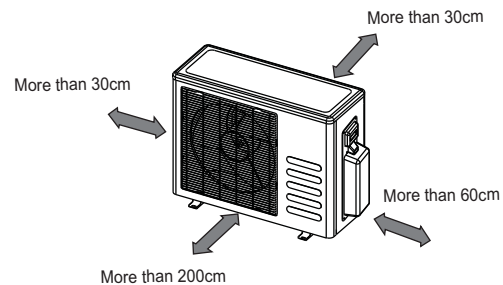

Fig.2

Rooftop installation:

- If the outdoor unit is installed on a roof structure, be sure to level the unit.
- Ensure the roof structure and anchoring method are adequate for the unit location.
- Consult local codes regarding rooftop mounting.
- If the outdoor unit is installed on roof structures or external walls, this may result in excessive noise and vibration, and may also be classed as a non serviceable installation.

INSTALLATION INSTRUCTIONS

Tools needed for installation:

Level gauge	Vacuum pump
Screwdriver	Gauge manifold
Electric drill, Hole core drill (ϕ 65mm)	Users manual
Flaring tool set	Thermometer
Specified torque wrenches: 1.8kgf.m, 4.2kgf.m, 5.5kgf.m, 6.6kgf.m(different depending on model No.)	Multimeter
Spanner (half union)	Pipe cutter
Hexagonal wrench (4mm)	Measuring tape
Gas-leak detector	

Accessories

Number	Name of Accessories		Q' ty/one unit
1	Installation Plate		1
2	Plastic Expansion Sheath		5-8 (depending on models)
3	Self-tapping Screw A ST3.9X25		5-8 (depending on models)
4	Connecting pipe Assembly	Liquid side	Parts you must purchase Consult the technician for the proper size.
		ϕ 9.52	
	Gas side	ϕ 9.52	
			ϕ 12.7
			ϕ 15.9
5	Remote controller		1
6	Self-tapping Screw B ST2.9X10	Optional parts	2
7	Remote controller holder		1
8	Seal (for cooling& heating models only)		1
9	Drain Joint (for cooling& heating models only)		1
10	Transfer connector(Packed with the indoor unit) (NOTE: Pipe size differ from appliance to appliance. To meet different pipe size requirement, sometimes the pipe connections need the transfer connector to install on the outdoor unit .)		3-4 (on some models)
11	Magnetic ring (Hitch it on the connective cable between indoor unit and outdoor unit after installation.)		Optional part (one piece/one cable)
12	Cord protection rubber ring (If the cord clamp can not fasten the cord for the small size of the cord, please use the cord protection rubber ring (supplied with accessories) to wrap on the cord, then fix it with the cord clamp.)		1 (on some models)

Note: Except the above parts provided, the other parts needed during installation you must purchase.

INSTALLATION INSTRUCTIONS

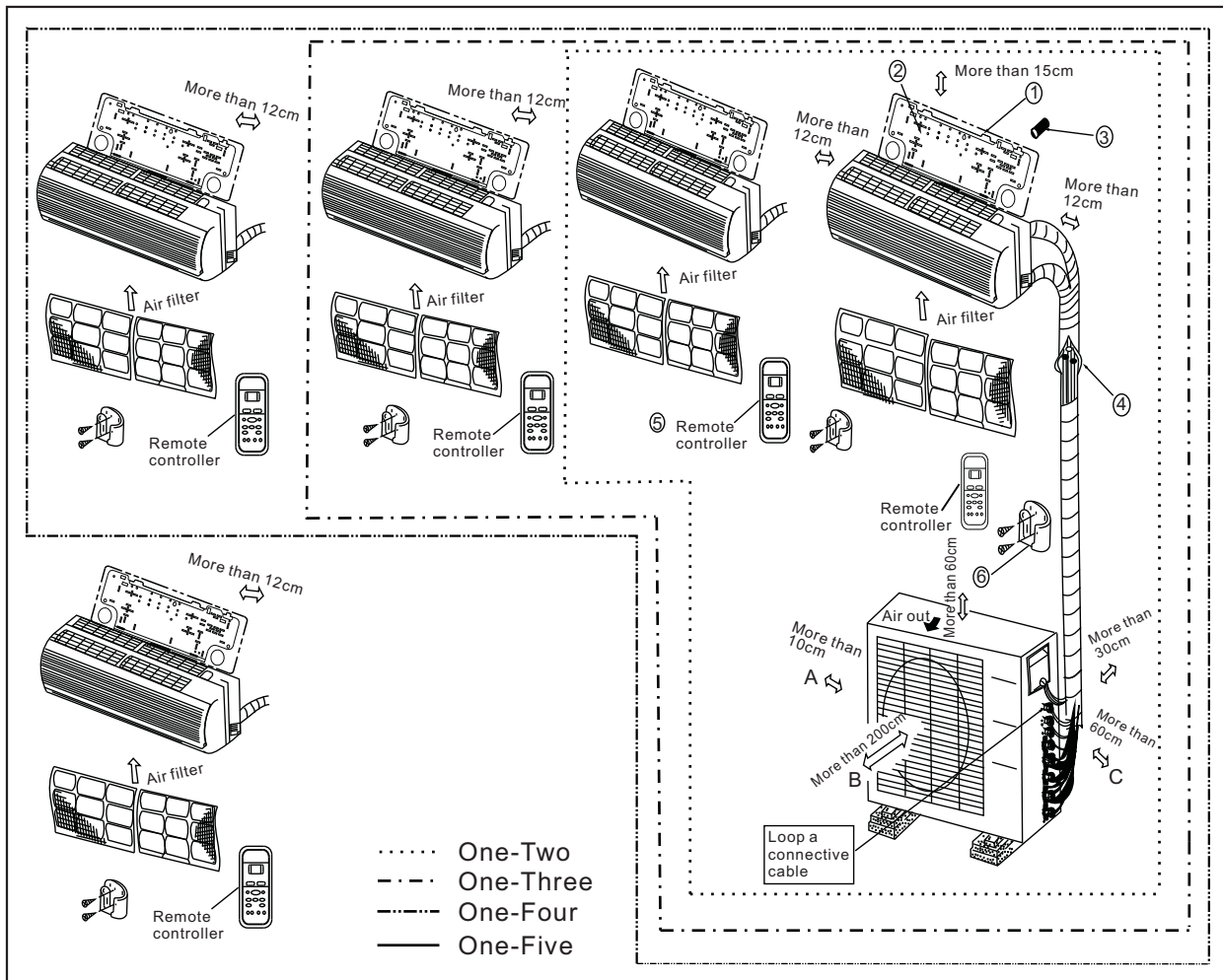

Fig.3



CAUTIONS

- This illustration is for explanation purposes only. The actual shape of your air conditioner may be slightly different.
- Copper lines must be insulated independently

CAUTION

- Use a stud finder to locate studs to prevent unnecessary damage to the wall.
- A minimum pipe run of 3 metres is required to minimise vibration & excessive noise.
- Two of the A, B and C directions should be free from obstructions.

INSTALLATION INSTRUCTIONS

Indoor unit installation(wall-mounted type)

1. Fit the Installation Plate

1. Fit the installation plate horizontally on structural parts of the wall with spaces around the installation plate.
2. If the wall is made of brick, concrete or the like, drill five or eight 5mm diameter holes in the wall. Insert Clip anchor for appropriate mounting screws.
3. Fit the installation plate on the wall with five or eight type A screws.

Correct orientation of Installation Plate

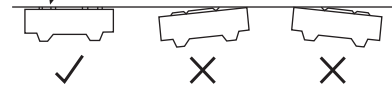

Fig.4

Note:

Fit the Installation Plate and drill holes in the wall according to the wall structure and indoor unit dimensions and the corresponding mounting points on the installation plate. The Installation Plate may be slightly different according to the different models of indoor unit. See Fig.5 for example.

(Dimensions are in mm unless otherwise stated.)

Indoor unit dimension mm(WxH)	Mounting dimensions	
	L(Left)	R(Right)
710x250	100	160
790x265	100	150
920x292	150	185
1080x330	70	105
790x275	100	85
930x275	150	205
998x322	100	120
680x255	170	92
770x255	170	95
905x275	80	100
750x280	180	110
835x280	140	110
990x315	260	135
1186x343	275	275
900x290	83	170
1045x305	100	170
715x250	85	88
800x275	100	95
940x275	110	100
1045x315	293	163
795x270	150	160
845x286	150	186
995x295	150	200
1084x320	150	140
850x275	100	130
900x285	150	90
1015x298	150	200
850x290	100	115

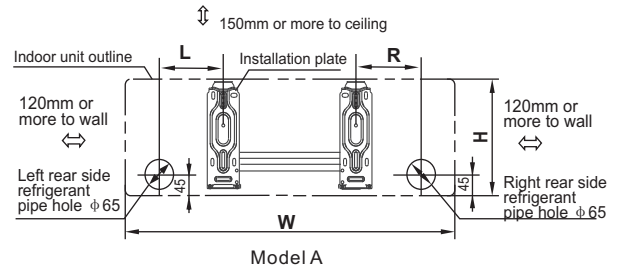

Model A

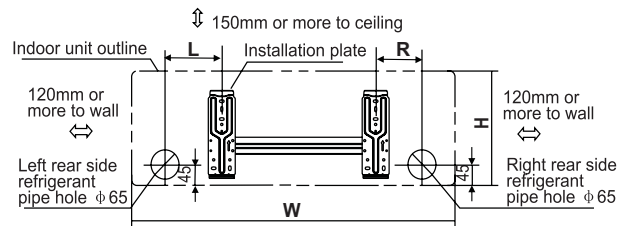

Model B

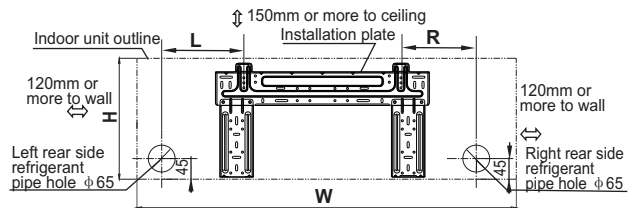

Model C

Fig.5

INSTALLATION INSTRUCTIONS

2. Drill a hole in the wall

1. Determine hole positions according to the diagram detailed in Fig.5. Drill one (1) hole ($\phi 65\text{mm}$) slanting slightly to outdoor side.
2. Always use wall hole conduit when drilling metal grid, metal plate or the like.

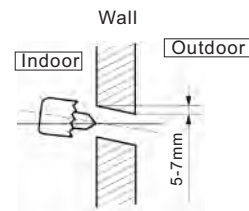

Fig.6

3. Connective Pipe and Drainage Installation

Drainage

1. Run the drain hose sloping downward. Do not install the drain hose as illustrated in Fig.7.
2. When connecting extension drain hose, insulate the connecting part of extension drain hose with a shield pipe, do not let the drain hose slack.

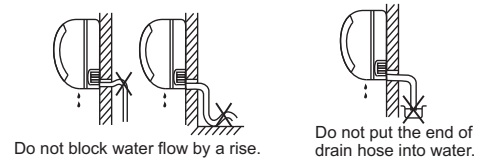

Fig.7

Connective pipe installation

1. For the left-hand and right-hand piping, remove the pipe cover from the side panel.
2. For the rear-right-hand and rear-left-hand piping, install the piping as shown in Fig.10.
3. Fix the end of the connective pipe. (Refer to Tightening Connection in REFRIGERANT PIPING CONNECTION)

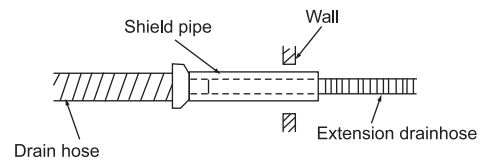

Fig.8

4. Piping and wrapping

Bundle the tubing, connecting cable, and drain hose with tape securely, evenly as shown in Fig.11.

- Because the condensed water from rear of the indoor unit is gathered in ponding box and is piped out of room. Do not put anything else in the box.

CAUTION

- Connect the indoor unit first, then the outdoor unit.
- Do not allow the piping to let out from the back of the indoor unit.
- Be careful not to let the drain hose slack.
- Heat insulated both of the auxiliary piping.
- Be sure that the drain hose is located at the lowest side of the bundle. Locating at the upper side can cause drain pan to overflow inside the unit.
- Never intercross nor intertwist the power wire with any other wiring.
- Run the drain hose sloped downward to drain out the condensed water smoothly.

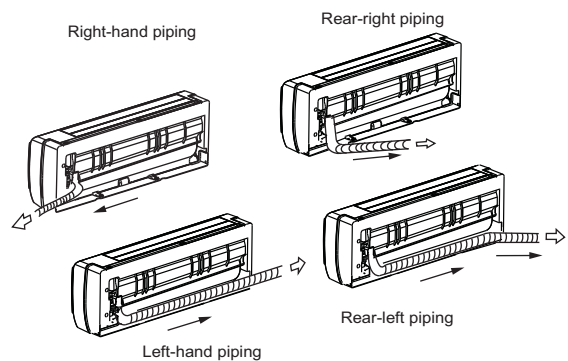

Fig.9

Fig.10

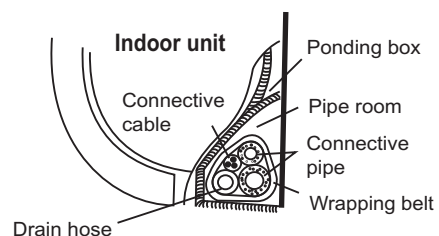

Fig.11

INSTALLATION INSTRUCTIONS

4. Indoor unit installation

1. Pass the piping through the hole in the wall.
2. Put the upper claw at the back of the indoor unit on the upper hook of the installation plate, move the indoor unit from side to side to see that it is securely hooked (see Fig.12).
3. Piping can easily be made by lifting the indoor unit with a cushioning material between the indoor unit and the wall. Get it out after finish piping.
4. Push the lower part of the indoor unit up on the wall, then move the indoor unit from side to side, up and down to check if it is hooked securely.

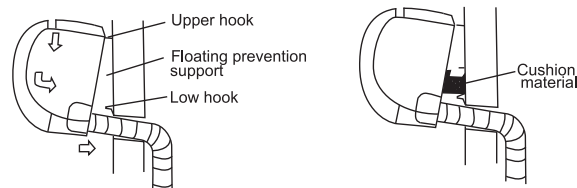

Fig.12

Indoor units that can be used in combination	Number of connected units	1-5units
Compressor stop/start frequency	Stop time	3 min or more
Power source voltage	Voltage fluctuation	within $\pm 10\%$ of rated voltage
	Voltage drop during start	within $\pm 15\%$ of rated voltage
	Interval unbalance	within $\pm 3\%$ of rated voltage







		1 drive 2	1 drive 3	1 drive 4	1 drive 5
Max. Length for all rooms		30m	45m	60m	75m
Max. Length for one indoor unit		20m	25m	30m	30m
Max. height different between indoor and outdoor unit	OU higher than IU	10m	10m	10m	10m
	OU lower than IU	15m	15m	15m	15m
Max. height different between indoor units		10m	10m	10m	10m

INSTALLATION INSTRUCTIONS

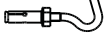
2. Four-way cassette type

Attached fittings

Please check whether the following fittings are of full scope. If there are some attached fittings free from use, please restore them carefully.

	(on some models)	(on some models)
1. Installation manual.....1	5. Out-let pipe sheath.....1	11. Expansible hook.....4
2. Owner's manual.....1	6. Out-let pipe Clasp.....1	
3. Remote controller.....1	7. Drain joint.....1	12. Installation hook.....4
	8. Installation paper board.....1	
4. Alkaline dry batteries (AM4).....2		13. Orifice.....1
	9. Soundproof / insulation sheath.....1	14. Frame.....1
	10. Seal ring.....1	15. Mounting screw(ST2.9×10-C-H) ...2
		

Notes before installation

1. Decide the correct carry-in path.
2. Move this unit as originally packaged as possible.
3. If the air conditioner is installed on a metal part of the building, it must be electrically insulated according to the relevant electrical code.
4. If installing in a lonely building or at a high position where it is hot and humid with frequent thunderstorm, lightning-protection equipment is necessary.

Indoor unit installation

1. Install the main body

- A. The existing ceiling (to be horizontal)
- a. Please cut a quadrangular hole of 600×600mm in the ceiling according to the shape of the installation paper board. (Refer to Fig.15 & 16)
 - The center of the hole should be at the same position of that of the air conditioner body.
 - Determine the lengths and outlets of the connecting pipe, drain pipe and cables.
 - To balance the ceiling and to avoid vibration, please enforce the ceiling when necessary.
 - b. Please select the position of installation hooks according to the hook holes on the installation board.
 - Drill four holes of $\phi 12$ mm, 50~55mm deep at the selected positions on the ceiling. Then embed the expansible hooks(fittings).
 - Face the concave side of the installation hooks toward the expansible hooks. Determine the length of the installation hooks from the height of ceiling, then cut off the unnecessary part.
 - If the ceiling is extremely high, please determine the length of the installation hook according to facts.
 - Cut the installation hook open in the middle position, then use appropriate length of reinforcing rod ($\phi 12$) to weld together.

Necessary room

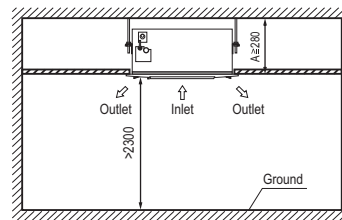

Fig.13

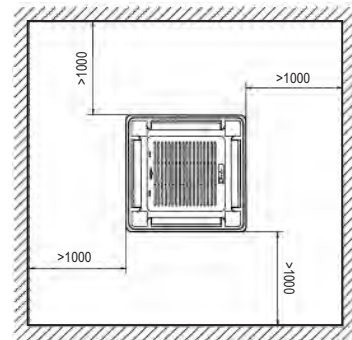

Fig.14

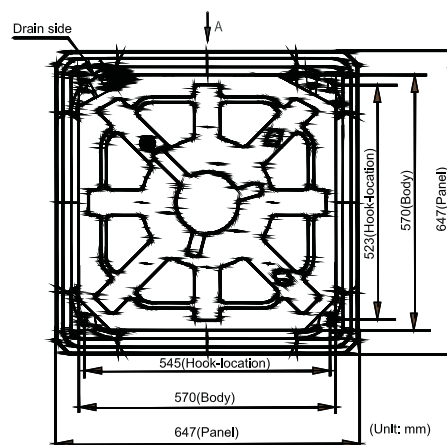

Fig.15

INSTALLATION INSTRUCTIONS

The length could be calculated from Fig.17:
 $\text{Length} = 210 + L$ (in general, L is half of the whole length of the installation hook)

- c. Please adjust the hexangular nuts on the four installation hooks evenly, to ensure the balance of the body.
 - Use the transparent hose filled with water to check the lever of the main body from the four sides or diagonal line direction, the lever indicator also can check the lever from four sides of the main body. (Refer to Fig.18)
 - If the drainpipe is awry, leakage will be caused by the malfunction of the water-level switch.
 - Adjust the position to ensure the gaps between the body and the four sides of ceiling are even.
 - The body's lower part should sink into the ceiling for 10~12mm (Refer to Fig.17).
 - Locate the air conditioner firmly by wrenching the nuts after having adjusted the body's position well.

New built houses and ceilings

- a. In the case of new built house, the hook can be embedded in advance (refer to the A.b mentioned above). But it should be strong enough to bear the indoor unit and will not become loose because of concrete shrinking.
- b. After installing the body, please fasten the installation paper board onto the air conditioner with bolts ($M5 \times 16$) to determine in advance the sizes and positions of the hole opening on ceiling. Please first guarantee the flatness and horizontal of ceiling when installing it. Refer to the A.a mentioned above for others.
- c. Refer to the A.c mentioned above for installation.
- d. Remove the installation paper board.

2. Install The Panel

CAUTIONS

- Never put the panel face down on floor or against the wall, or on bulgy objects.
- Never crash or strike it.

(1) Remove the inlet grid.

- a. Slide two grid switches toward the middle at the same time, and then pull them up. (Refer to Fig.21)
- b. Draw the grid up to an angle of about 30° , and remove it. (Refer to Fig.22)

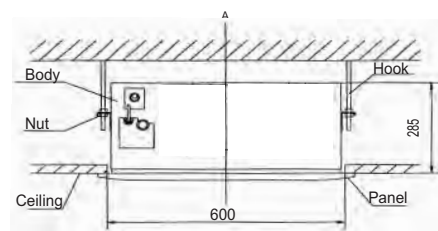

Fig. 16

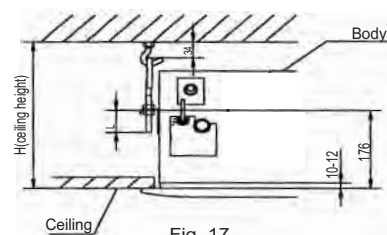

Fig. 17

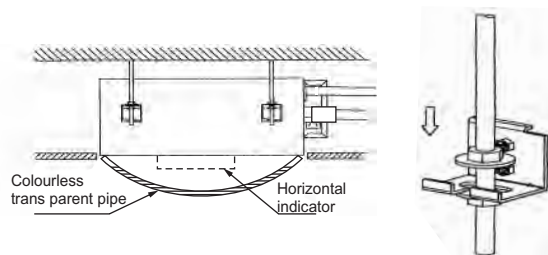

Fig.18

Fig.19

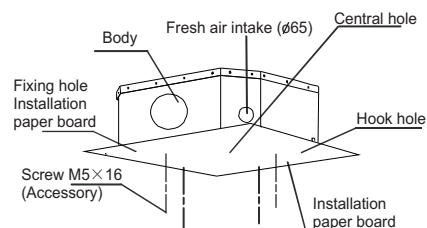

Fig.20

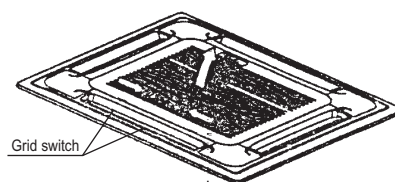

Fig.21

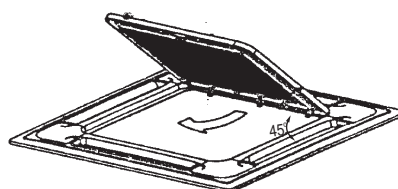

Fig.22

INSTALLATION INSTRUCTIONS

(2) Install the panel

- a. Align the swing motor on the panel to the water receiver of the body properly. (Refer to Fig.23)
- b. Hang the four fixed rope of the main body to the installation cover and the other three covers of the swing motor: (Refer to Fig.23)

CAUTIONS:

The installation cover of the swing motor must sink into the corresponding water receiver.

- c. Install the panel on the main body with bolt (M5×16) and washer. (Refer to Fig.23)
 - d. Adjust the four panel hook screws to keep the panel horizontal, and screw them up to the ceiling evenly.
 - e. Regulate the panel in the direction of the arrow in Fig.11 slightly to fit the panel's center to the center of the ceiling's opening. Guarantee that hooks of four corners are fixed well.
 - f. Keep fastening the screws under the panel hooks, until the thickness of the sponge between the body and the panel's outlet has been reduced to about 4~6mm. The edge of the panel should contact with the ceiling well. (Refer to Fig.24) Malfunction described in Fig.25 can be caused by inappropriate tightness the screw. If the gap between the panel and ceiling still exists after fastening the screws, the height of the indoor unit should be modified again. You can modify the height of the indoor unit through the openings on the panel's four corners, if the lift of the indoor unit and the drainpipe is not influenced (refer to Fig.26-right).
- (3) Hang the air-in grid to the panel, then connect the lead terminator of the swing motor and that of the control box with corresponding terminators on the body respectively.
 - (4) Relocate the air-in grid in the procedure of reversed order, install the air-in grid.

(3) The installation of ventilation motor and ventilation pipe (if necessary)

- a. Using a tool to knock off the pre-punching hole. (Refer to Fig.27)
- b. Four screw hole reserved for installation. (Refer to Fig.27)

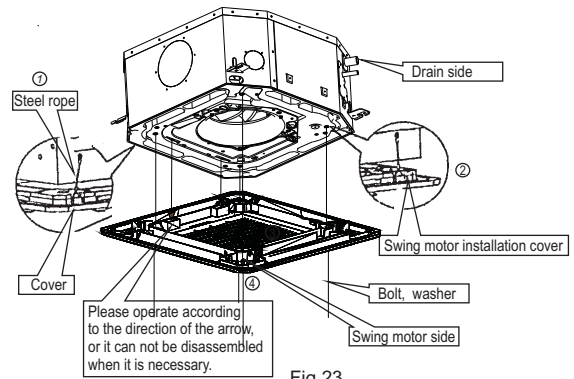

Fig.23

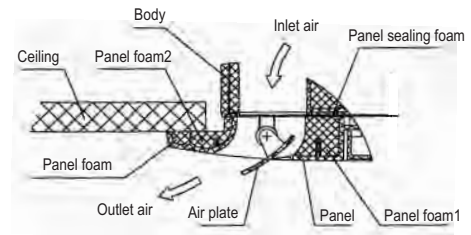

Fig.24

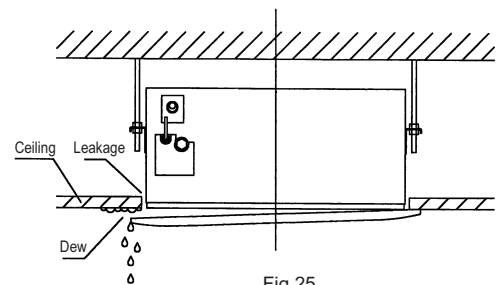

Fig.25

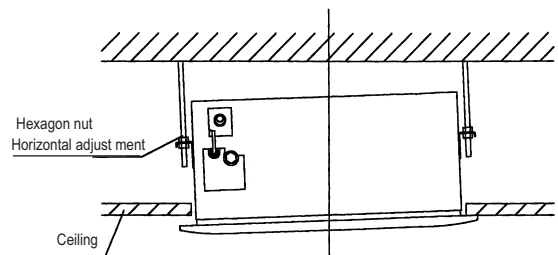

Fig.26

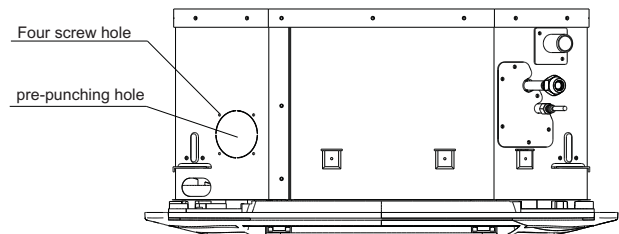

Fig.27

INSTALLATION INSTRUCTIONS

(4) water-pump drainage

The maximum lifting height is 750mm.

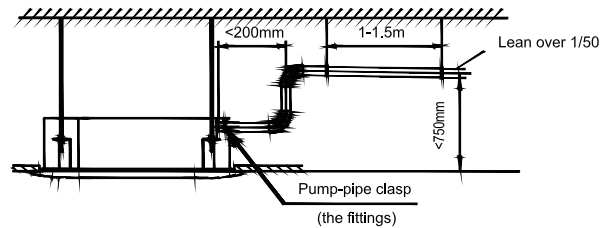

Fig.28

3. Drainage pipe installation

(1) Installation principle

- Ensure at least 1/100 slope of the drainage pipe.
- Adopt suitable pipe diameter.
- Adopt nearby condensate water discharge.
- Before installing condensate water pipeline, determine its route and elevation to avoid intersection with other pipelines and ensure slope is straight.
- In general, the supporter gap of the drainage pipe horizontal pipe and vertical pipe is respectively $1\text{m}\sim 1.5\text{m}$ and $1.5\text{m}\sim 2.0\text{m}$.

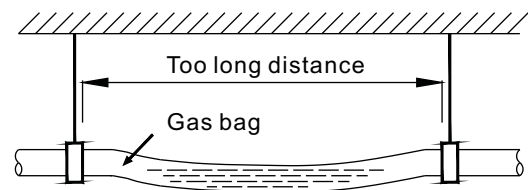

Fig.29

(2) Drainage pipe selection

- The drainage pipe diameter shall not small than the drain hose of indoor unit.
- According to the water flowrate and drainage pipe slope to choose the suitable pipe, the water flowrate is decided by the capacity of indoor unit.

Capacity(x1000Btu/h)	Water flowrate(l/h)
12	2.4
18	4
24	6
30	7
36	8
42	10
48	12
60	14

- According to the above table to calculate the total water flowrate for the confluence pipe selection.

INSTALLATION INSTRUCTIONS

For horizontal drainage pipe(The following table is for reference)
Attention: Adopt PVC40 or bigger pipe to be the main pipe.

PVC pipe	Reference value of inner diameter of pipe (mm)	Allowable maximum water flowrate (l/h)		Remark
		Slope 1/50	Slope 1/100	
PVC 25	20	39	27	For branch pipe
PVC 32	25	70	50	
PVC 40	31	125	88	Could be used for confluence pipe
PVC 50	40	247	175	
PVC 63	51	473	334	

For vertical drainage pipe(The following table is for reference)
Attention: Adopt PVC40 or bigger pipe to be the main pipe.

PVC pipe	Reference value of inner diameter of pipe (mm)	Allowable maximum water flowrate (l/h)	Remark
PVC 25	20	220	For branch pipe
PVC 32	25	410	
PVC 40	31	730	Could be used for confluence pipe
PVC 50	40	1440	
PVC 63	51	2760	

- The horizontal pipe layout should avoid converse flow or bad flow:

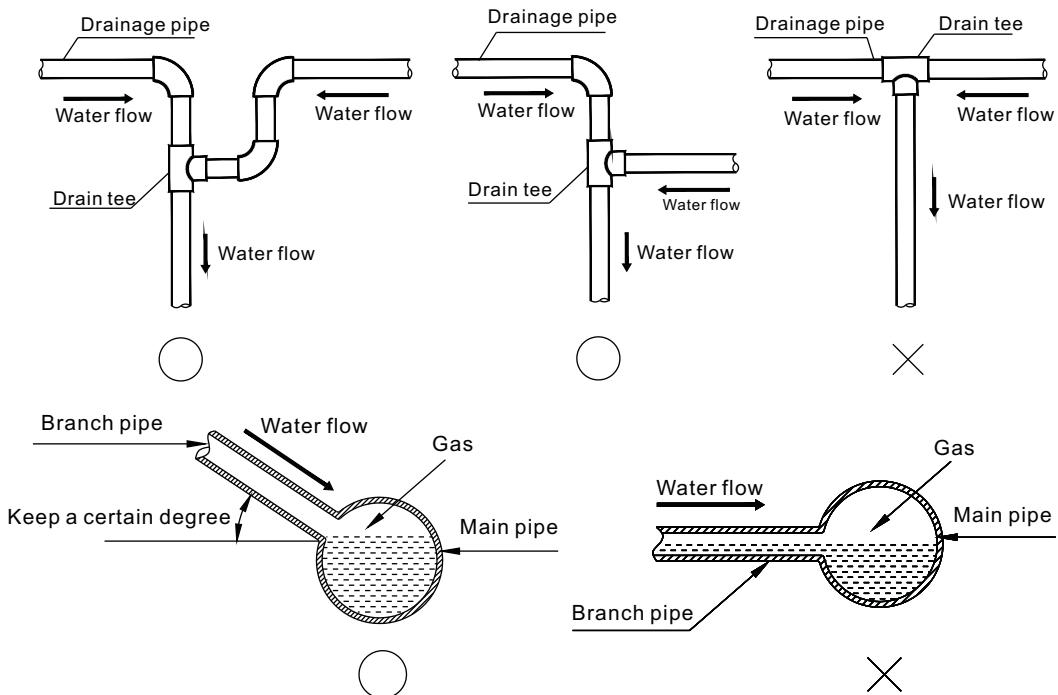

Fig.30

INSTALLATION INSTRUCTIONS

(3) Water storage pipe setting

- If the indoor unit has high extra static pressure and without water pump to elevate the condensate water, such as high extra static pressure duct unit, the water storage pipe should be set to avoid converse flow or blow water phenomena.

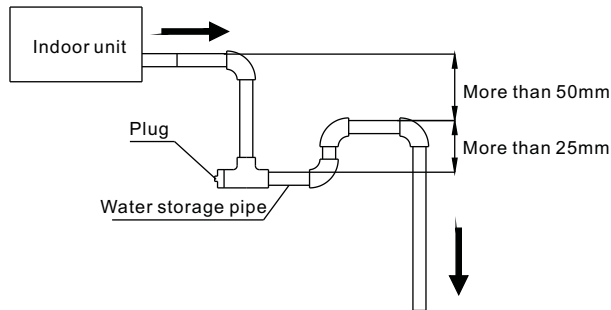

Fig.31

(4) Lifting pipe setting of indoor unit with water pump

- The length of lifting pipe should not exceed the pump head of indoor unit water pump.
- Pump head of big four way cassette: 750mm.
- Pump head of compact four way cassette: 500mm(9k, 12k, 18k units).
- The drainage pipe should be set down inclined after the lifting pipe immediately to avoid wrong operation of water level switch.
- Refer the following picture for installation reference.

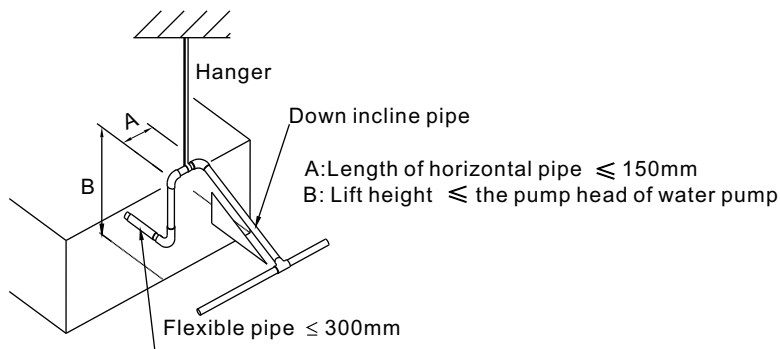

Fig.32

(5) Blowhole setting

- For the concentrated drainage pipe system, there should design a blowhole at the highest point of main pipe to ensure the condensate water discharge smoothly. The air outlet shall face down to prevent dirt entering pipe. Each indoor system should be installed it. The installation should be considering the convenience for future cleaning.

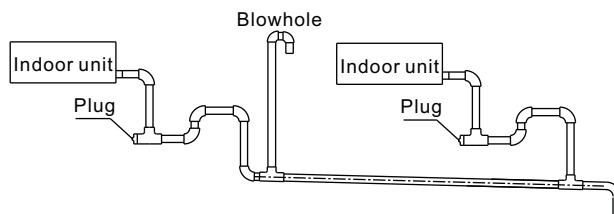

Fig.33

INSTALLATION INSTRUCTIONS

3. Duct & Ceiling type

Installation precautions

1. Determine the moving route.
2. Move the unit in original state.
3. Make sure to do electric insulation according to relevant electric standard in case the unit is installed on metal part of building.
4. Please keep away from the following places, or malfunction may be caused. (if unavoidable, please consult the professionals):
 - A. There is mineral oil like the oil of cutting machine.
 - B. There is much salty air. (Near the coast)
 - C. There is caustic gas such as sulfuric gas. (Near the hot spring.)
 - D. Factory where the voltage fluctuate greatly.
 - E. In the car or in the cabin.
 - F. In the kitchen or a place full of oil steam..
 - G. There is strong electromagnetic wave.
 - H. There is combustible gas or materials.
 - I. There is much evaporating acid or alkaline gas.
 - J. Other special areas.

Accessories

NO	Name	Qty.	Outline	Function
1	Insulation pipe	2		Pipe joint heat insulation
2	Remote controller	1	—	Remote control air conditioner
3	Big washer	8	—	Overhang indoor unit
4	Constriction bandage	10	—	Binding insulation pipe
5	Water outlet joint (for cool/heat type only)	1	—	Outdoor unit drainage
6	Gasket (for cool/heat type only)	1	—	Outdoor unit drainage
7	Copper nut	2	—	Connecting pipe
8	Drain hose	1	—	Indoor unit drainage
9	7# Alkaline battery	1	—	—
10	Remote signal receiver subassembly	1	—	—
11	Magnetic ring	1	—	—

Indoor unit installation

◆ Installation location

- Enough room for installation and maintenance.

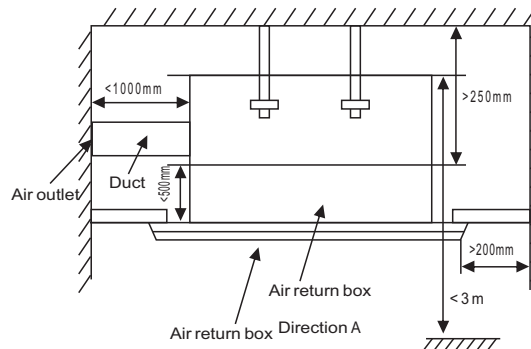
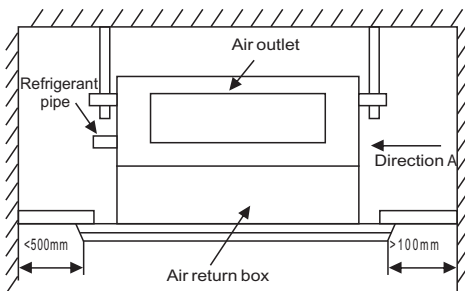

- The ceiling is horizontal and it can afford the weight of the indoor unit.
- The air inlet and outlet are not impeded and does not affected by outdoor air too much.
- The air flow can reach every part of the room.
- The connecting pipe and drainpipe can be easily extracted out.
- There is no direct radiation from heat source.

INSTALLATION INSTRUCTIONS

◆ Installation of unit

Install $\phi 10$ (4 pieces) hanging screw bolt

- Determine the location of hanging screw bolt following Fig.40.
- Make sure to use the hanging screw bolt of $\phi 10$.
- The treatment to the ceiling varies from construction; please consult the professionals for details.
 - 1) Treatment to ceiling---make sure to consolidate the roof beam for possible vibration to keep the ceiling horizontal.
 - 2) Please cut off the roof beam.
 - 3) Reinforce the place that is cut off and consolidate the roof beam.
- Carry out connection of piping and wiring inside the ceiling.
- Determine the piping direction. Especially in the case of existing ceiling, please pull the wire to the connection place before overhanging the unit.

Install the hanging bolt in following different situation:

Wooden structure

Put a timber across the beams and install the bolts.

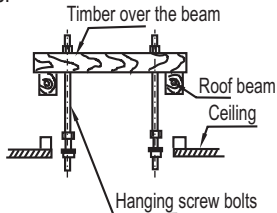

Fig.34

Original concrete bricks

Install the hanging hook with expansible bolt into the concrete.

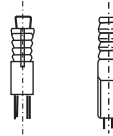

Fig.35

New concrete bricks

Install with insertion or embedding screw.

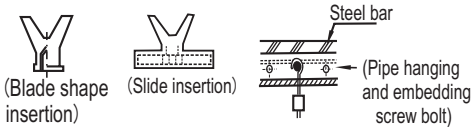

Fig.36

Steel roof beam structure

Install the supporting angle steel.

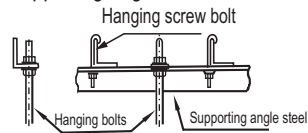

Fig.37

Overhang the unit

- Install the hanging screw bolt to the U-shaped slot of installation ear. Overhang the indoor unit and measure the level degree of unit with a gradienter.
- Fasten and fix the upside nut.

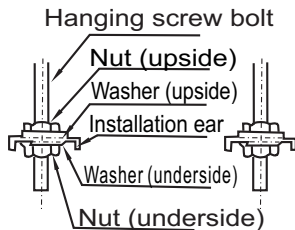

Fig.38

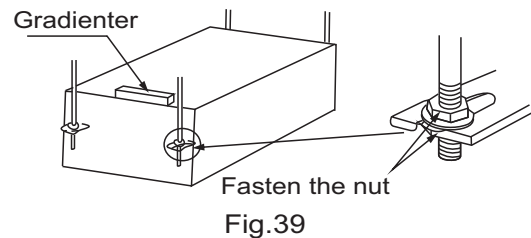

Fig.39

INSTALLATION INSTRUCTIONS

The position of hanging bolts

Dimension and air outlet size

Unit: mm

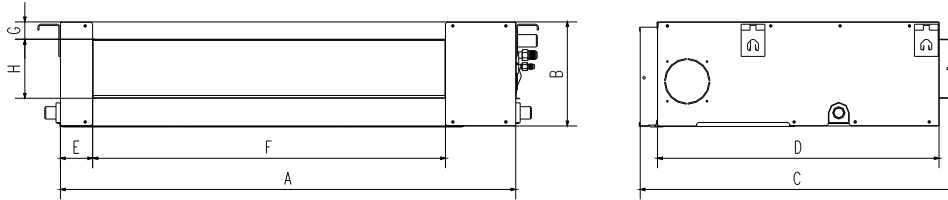

Air inlet size

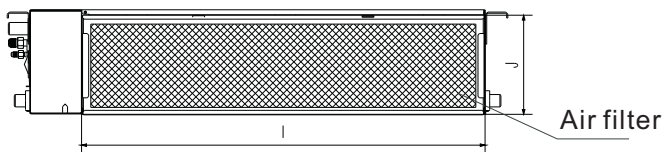

Position size of descensional ventilation opening

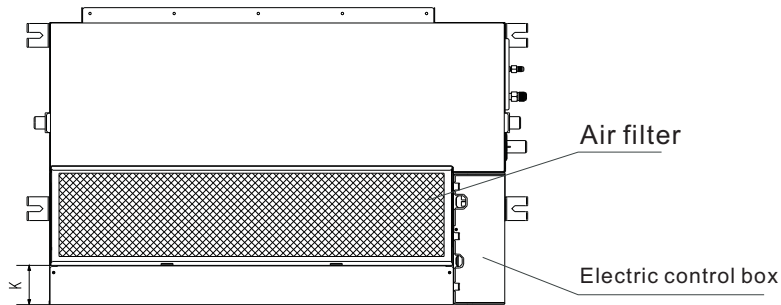

Size of mounted hook

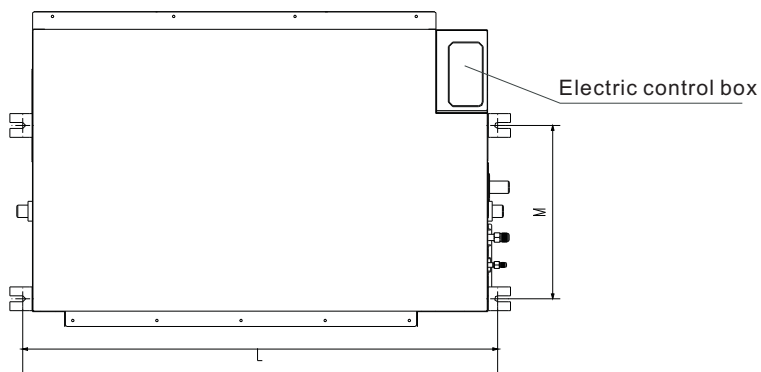

Fig.40

INSTALLATION INSTRUCTIONS

	Outline dimension				Air outlet opening size				Air return opening size			Size of mounted lug	
	A	B	C	D	E	F	G	H	I	J	K	L	M
≤12000Btu/h	700	210	635	570	65	493	35	119	595	200	80	740	350
>12000Btu/h	920	210	635	570	65	713	35	119	815	200	80	960	350

How to adjust the air inlet direction?(From rear side to under-side.)

- Take off ventilation panel and flange, cut off the staples at side rail.
- Stick the attached seal sponge as per the indicating place in the following fig, and then change the mounting positions of air return panel and air return flange .
- When install the filter mesh, please plug it into flange inclined from air return opening, and then push up.
- The installation has finish, upon filter mesh which fixing blocks have been insert to the flange positional holes.

Labels in diagrams: Air return flange, Side rail, Dentilation panel, Seal sponge.

Fig.41

NOTE

All the figures in this manual are for explanation purpose only. They may be slightly different from the air conditioner you purchased. The actual unit shall prevail.

INSTALLATION INSTRUCTIONS

Drainpipe installation

1. Indoor unit drainpipe installation

Piping, insulation material

Piping	Hard PVC pipe
Insulation material	Cellular polyethylene, thicker than 6mm

Drainage

See Fig.42

Heat insulation

- Please do heat insulation on piping joint.
- Bind the contact insulation part between the unit and installation location with bandage.

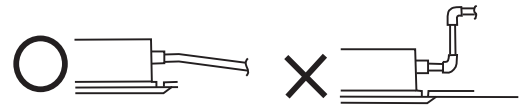

Fig.42

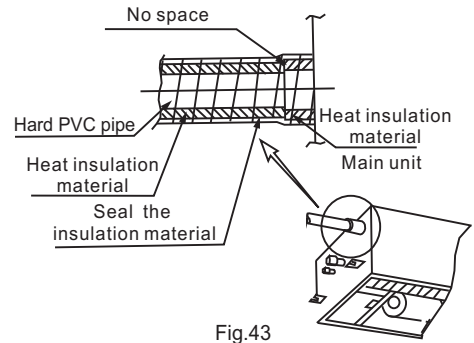

Fig.43

INSTALLATION INSTRUCTIONS

CAUTION

- The drain pipe as well as the connection part of indoor unit must be heat insulated, or condensate will occur.
- Please connect the pipe with horny PVC bond and make sure there is no leakage.
- Do not impose the pressure on connecting part of drainpipe.
- The gradient downwards of drain pipe should be over 1/100, and do not bend the drain pipe.
- Pull the drain pipe transversely within 20m. Please install a supporter in case the drainpipe is very long to prevent it from bending.
- Refer to the figures on the right for the installation of pipes.

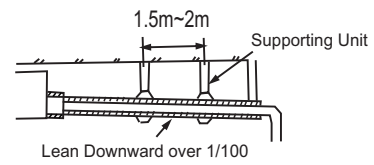

Fig.44

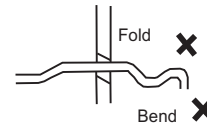

Fig.45

Instructions for duct installation accessories

Duct design

Make the duct as short as possible due to the low static pressure (nearly 0 pa) of this unit.

Fix installation board

Fix the installation board on duct outlet with the bolts in accessories. If the bolt is self-provided, the length of bolt should be appropriate and make sure not to damage the inside of unit. See Fig.47

Duct installation

Fix the duct on installation board with rivet.

See Fig.48

NOTE:

1. Do not let the indoor unit bear the weight of duct.
2. For convenient maintenance, install the duct at the place where it is easy to do removing.
3. In case doing installation in meeting room or such places, please equip the interior with liner and muffler.
4. These accessories are optional. Please contact the service for other requirement.

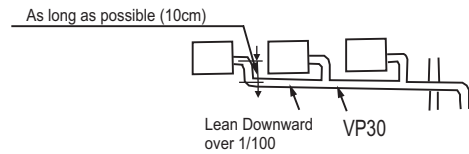

Fig.46

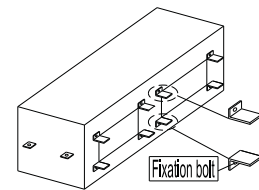

Fig.47

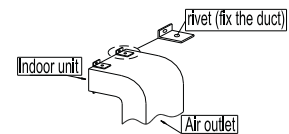

Fig.48





Accessories





Name	Qty.	Outline/specification	Function
Duct installation board	8		Connecting duct
Fixation bolt (fixing installation board)	8	ST3.9×10-F-H	Fixing duct installation board

INSTALLATION INSTRUCTIONS

4. Ceiling and Floor type

4.1 Accessories

Name of Accessories	Q'ty	Outline	Usage
Owner's manual	1		—————
Installation manual	1	(This manual)	—————
Hook	2		For wall mounting installation
Hanging arm	2		For ceiling installation
Magnetic ring	1		For wire connection

Remote Controller & Its Frame (on some models)	
1. Remote controller.....	1
	
2. Frame.....	1
	
3. Mounting screw (ST2.9x10-C-H).....	2
	
4. Alkaline dry batteries(AM4)	2
	

Cautions on remote controller installation

- Never throw or beat the controller.
- Before installation, operate the remote controller to determine its location in a reception range.
- Keep the remote controller at least 1m apart from the nearest TV set or stereo equipment. (It is necessary to prevent image disturbances or noise interferences.)
- Do not install the remote controller in a place exposed to direct sunlight or close to a heating source, such as a stove.
Note that the positive and negative poles are in right positions when loading batteries.

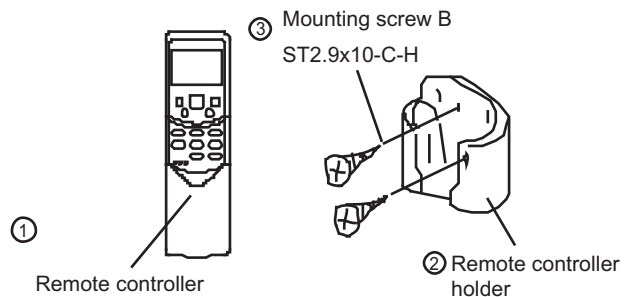

Fig.49-1

INSTALLATION INSTRUCTIONS

4.2 Indoor unit installation

1. Installing $\phi 10$ hanging screw bolts (4 bolts).

- Please refer to the following figure for the distance measurement between the screw bolts.
- Please install with $\phi 10$ hanging screw bolts.
- The handling to the ceiling varies from the constructions, consult the construction personnels for the specific procedures.
 - The size of the ceiling to be handled----do keep the ceiling flat. Consolidate the roof beam for possible vibration.
 - Cut off the roof beam.
 - Strengthen the place cut off, and consolidate the roof beam.
- Carry out the pipe and line operation in the ceiling after finishing the installation of the mainbody. While choosing where to start the operation, determine the direction of the pipes to be drawn out. Especially in case there is a ceiling, position the refrigerant pipes, drain pipes, indoor & outdoor lines to the connection places before hanging up the machine.
- The installation of hanging screw bolts.

2. Wooden construction

Put the square timber transversely over the roof beam, then install the hanging screw bolts. (Refer to Fig.49-2)

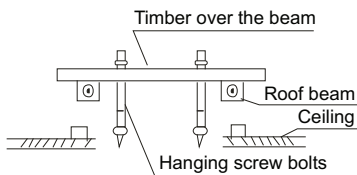

Fig.49-2

3. New concrete bricks

Inlaying or embedding the screw bolts. (Refer to Fig.49-3)



(Blade shape insertion)



(Slide insertion)

Fig.49-3

4. For original concrete bricks

Use embedding screw bold, crock and stick harness (Refer to Fig.49-4).

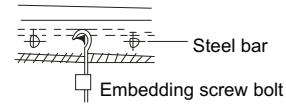

(Pipe hanging and embedding screw bolt)

Fig.49-4

5. Steel roof beam structre

Install and use directly the supporting angle steel. (Refer to Fig.49-5)

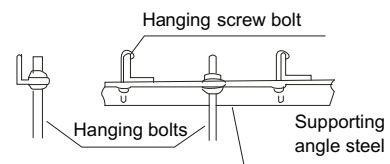

Fig.49-5

4.3 Wall Mounting Installation

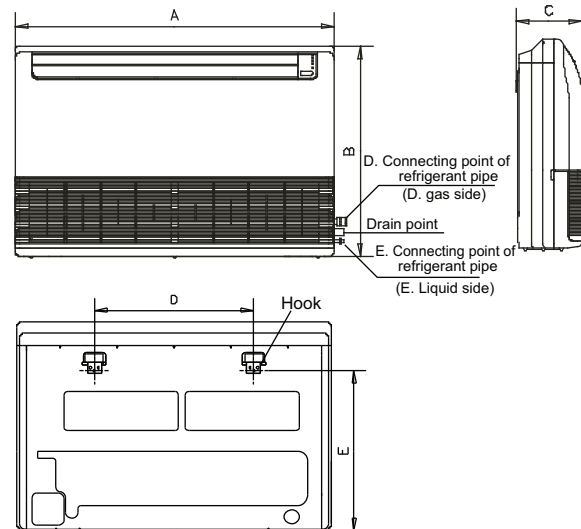

Fig.49-6

INSTALLATION INSTRUCTIONS

1. Fix the hook with tapping screw onto the wall. (Refer to Fig.49-7)
2. Hang the indoor unit on the hook.

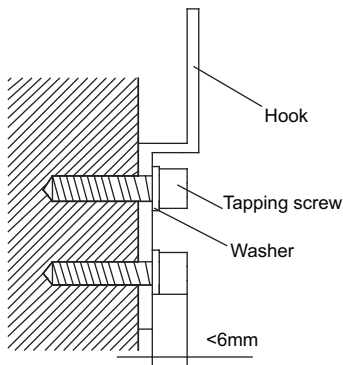

Fig.49-7

4.4 Ceiling Installation

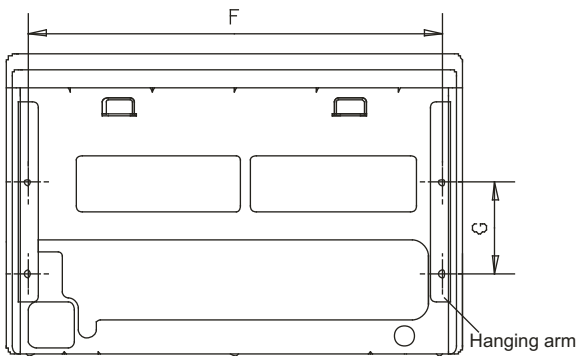

Fig.49-8

1. Remove the side board and the grille. (Refer to Fig.49-9) (For 48000Btu/h and 60000Btu/h models, do not remove the grille.)

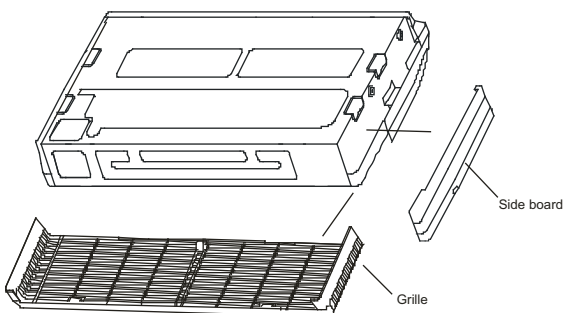

Fig.49-9

2. Location the hanging arm on the hanging screw bolt. (Refer to Fig.49-10)
Prepare the mounting bolts on the unit. (Refer to Fig.49-11)

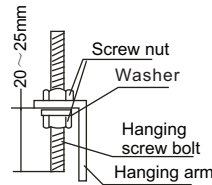

Fig.49-10

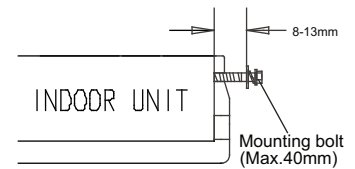

Fig.49-11

3. Hang the unit on the hanging arm by sliding backward. Securely tighten the mounting bolts on both sides. (Refer to Fig.49-12)

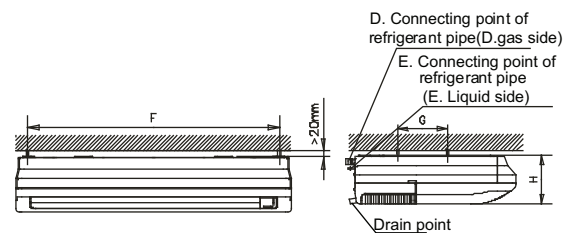
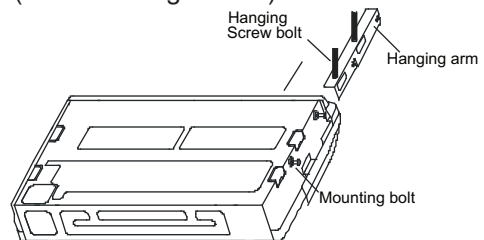

Fig.49-12

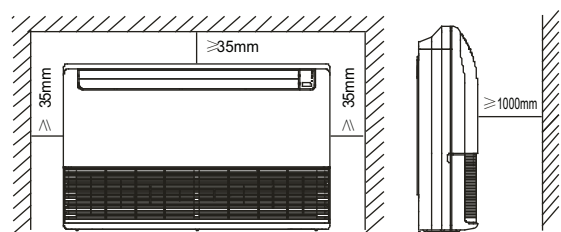

Fig.49-13

⚠ CAUTION

The figures above are based on model with 18000Btu/h as rated capacity, which may differ from the unit you purchased.

INSTALLATION INSTRUCTIONS

4.5 The Dimension of the Unit

Unit:mm







Capacity	A	B	C	D	E	F	G	H
12-18	990	660	206	505	506	907	200	203

Note: The dimension of 12000Btu/h and 18000Btu/h are the same.

5. Floor and Standing Type (Console)

5.1 Accessories(Console)

Please check whether the following fittings are of full scope. If there are some spare fittings, please restore them carefully.

	NAME	SHAPE	QUANTITY
Installation fittings	1. Hook		2
	2. Magnetic ring		1
Remote controller & Its Frame (on some models)	3. Remote controller		1
	4. Frame		1
	5. Mounting screw (ST2.9 10-C-H)		2
	6. Alkaline dry batteries (AM4)		2
Others	7. Owner's manual	—	1
	8. Installation manual	—	1

Cautions on remote controller installation:

- Never throw or beat the controller.
- Before installation, operate the remote controller to determine its location in a reception range.
- Keep the remote controller at least 1m apart from the nearest TV set or stereo equipment. (it is necessary to prevent image disturbances or noise interferences.)
- Do not install the remote controller in a place exposed to direct sunlight or close to a heating source, such as a stove.
- Note that the positive and negative poles are right positions when loading batteries.

- This manual is subject to changes due to technological improvement without further notices.

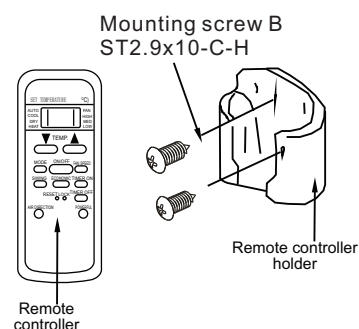



Fig.50-1

5.2 Inspecting and Handling the unit(Console)

At delivery, the package should be checked and any damage should be reported immediately to the service agent. When handling the unit, take into account the following:

1.  Fragile, handle the unit with care.
2.  Keep the unit upright in order to avoid compressor damage.
3. Choose on before hand the path along which the unit is to be brought in.
4. Move this unit as originally package as possible.
5. When lifting the unit , always use protectors to prevent belt damage and pay attention to the position of the unit's centre of gravity.

5.3 Indoor Unit Installation(Console)

5.3.1 Installation place

The indoor unit should be installed in a location that meets the following requirements:

- There is enough room for installation and maintenance. (Refer to Fig.50-2 & Fig.50-3)
- The outlet and the inlet are not impeded, and the influence of external air is the least.
- The air flow can reach throughout the room.
- The connecting pipe and drainpipe could be extracted out easily.
- There is no direct radiation from heaters.

INSTALLATION INSTRUCTIONS

⚠ CAUTION

Keep indoor unit, outdoor unit, power supply wiring and transmission wiring at least 1 meter away from televisions and radios. This is to prevent image interference and noise in those electrical appliances. (Noise may be generated depending on the conditions under which the electric wave is generated, even if 1 meter is kept.)

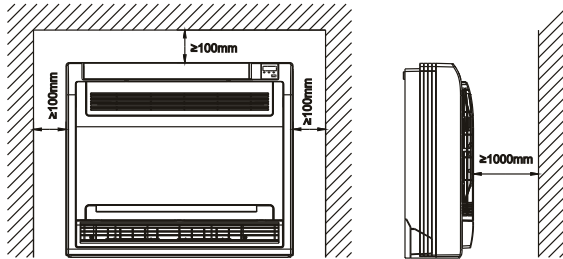

Fig.50-2

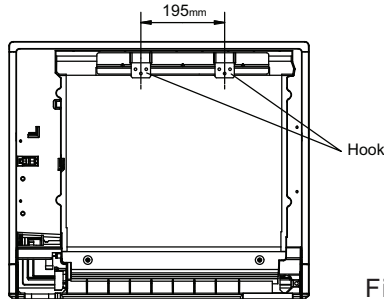
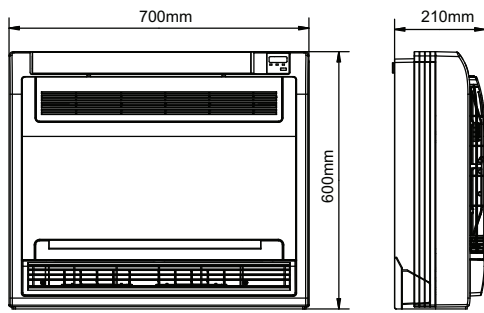

Fig.50-3

5.3.2 Install the main body

- Fix the hook with tapping screw onto the wall. (Refer to Fig.50-4)

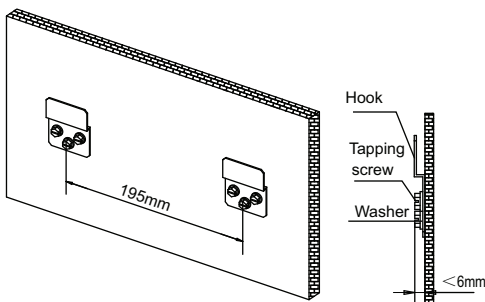

Fig.50-4

- Hang the indoor unit on the hook. (The bottom of body can touch with floor or suspended, but the body must install vertically.)

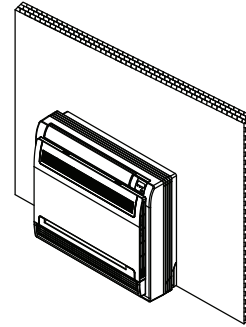

Fig.50-5

5.4 Install the connecting pipe (Console)

Check whether the height drop between the indoor unit and outdoor unit, the length of refrigerant pipe, and the number of the bends meet the following requirements:

Capacity(KBtu/h)	7/9/12	18/20/26/32/53
The max height drop	5m	10m
The length of refrigerant pipe	Less than 10m	Less than 20m
The number of bends	Less than 5m	Less than 5

5.4.1 The procedure of connecting pipes:

⚠ CAUTION

- All field piping must be provided by a licensed refrigeration technician and must comply with the relevant local and national codes.
- Do not let air, dust, or other impurities fall in the pipe system during the time of installation.
- The connecting pipe should not be installed until the indoor and outdoor units have been fixed already.
- Keep the connecting pipe dry, and do not let moisture in during installation.
- Execute heat insulation work completely on both sides of the gas piping and the liquid piping. Otherwise, this can sometimes result in water leakage.

INSTALLATION INSTRUCTIONS

1. Drill a hole in the wall (suitable just for the size of the wall conduit), then set on the fittings such as the wall conduit and its cover.
2. Bind the connecting pipe and the cables together tightly with binding tapes. Pass the bound connecting pipe through the wall conduct from outside. Be careful of the pipe allocation to do on damage to the tubing.
3. Connect the pipes. Refer to "How to Connect the pipes" for details.
4. Expel the air with a vacuum pump. Refer to "How to expel the air with a vacuum pump" for details.
5. open the stop valves of the outdoor unit to make the refrigerant pipe connecting the indoor unit with the outdoor unit in fluent flow.
6. Check the leakage. Check all the joints with the leak detector or soap water.
7. Cover the joints of the connecting pipe with the soundproof / insulating sheath (fittings), and bind it well with the tapes to prevent leakage.

⚠ CAUTION

Be sure to with insulating materials cover all the exposed parts of the flare pipe joints and refrigerant pipe on the liquid-side and the gas-side. Ensure that there is no gap between them. Incomplete insulation may cause water condensation.

How to take indoor unit apart to connect the pipes

1. Open the front panel

- Slide the two stoppers on the left and right sides inward until they click. See Fig.50-6.

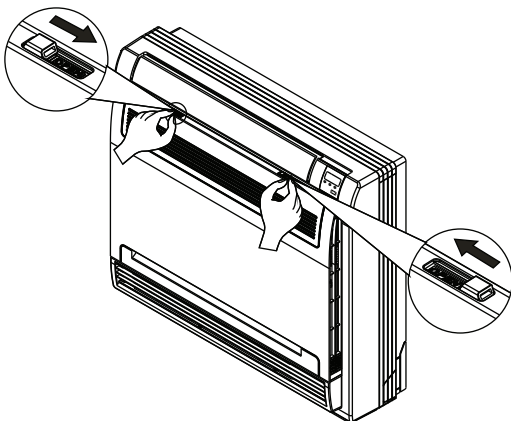

Fig.50-6

2. Remove the front panel

- Remove the string. (Refer to Fig.50-7).
- Allowing the front panel to fall forward will enable you to remove it.

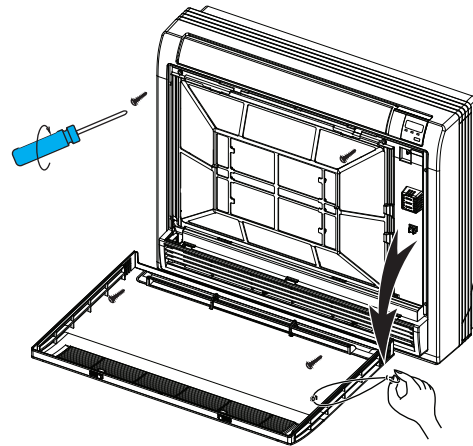

Fig.50-7

3. Remove the face plate

- Remove the four screws.(Refer to Fig.50-7).
- Opening bottom of face plate for a angle that is 30 degrees, then the top of face plate will be take up.(Refer to Fig.50-8)

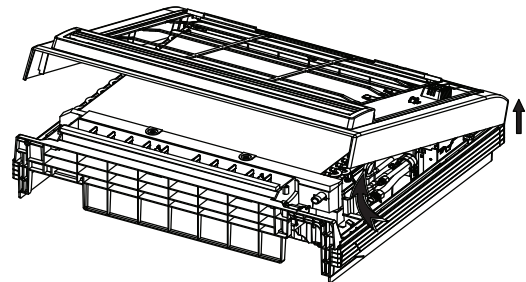

Fig.50-8

5.5 Connect the drain pipe(Console)

■ Install the drain pipe of the indoor unit

The outlet has PTI screw bread, Please use sealing materials and pipe sheath(fitting) when connecting PVC pipes.

⚠ CAUTION

- The drain pipe of indoor unit must be heat insulated, or it will condense dew, as well as the connections of the indoor unit.
- Hard PVC binder must be used for pipe connection, and make sure there is no leakage.
- With the connection part to the indoor unit, please be noted not to impose pressure on the side of indoor unit pipes.

INSTALLATION INSTRUCTIONS

- When the declivity of the drain pipe downwards is over 1/100, there should not be any winding.
- The total length of the drain pipe when pulled out transversely shall not exceed 20m, when the pipe is over long, a prop stand must be installed to prevent winding.
- Refer to the figures on the right for the installation of the pipes.

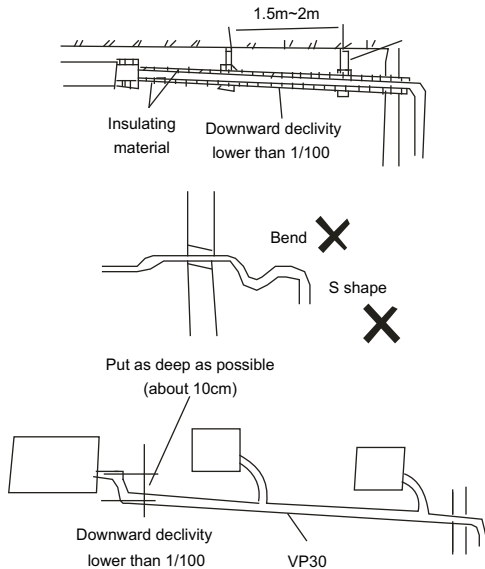

Fig.50-9

■ Drainage test

- Check whether the drain pipe is unhindered.
- New built house should have this test done before paving the ceiling.

5.6 Wiring(Console)

⚠ CAUTION

- The appliance shall be installed in accordance with national wiring regulations.
- The air conditioner should use separate power supply with rated voltage.
- The external power supply to the air conditioner should have ground wiring, which is linked to the ground wiring of the indoor and outdoor unit.
- The wiring work should be done by qualified persons according to circuit drawing.
- An all-pole disconnection device which has at least 3mm separation distance in all pole and a residual current device(RCD)with the rating of above 10mA shall be incorporated in the fixed wiring according to the national rule.

- Be sure to locate the power wiring and the signal wiring well to avoid cross-disturbance.
- Do not turn on the power until you have checked carefully after wiring.

5.6.1 Connect the cable

- The installation bearer of sensing device rotated to another side, and then takes off cover of electrical box. (Take off the electrical box if the capacity is 18000btu/h as well as using network function.) (Refer to Fig.50-10)

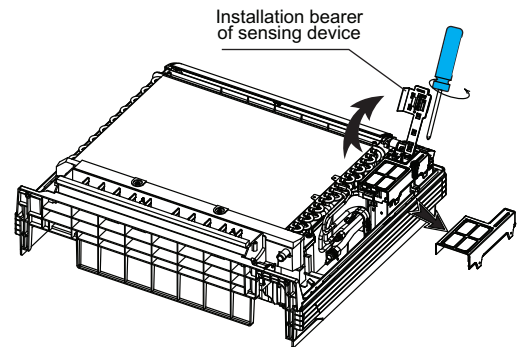

Fig.50-10

NOTE:

All the pictures in this manual are for explanation purpose only. They may be slightly different from the air conditioner you purchased(depend on model). The actual shape shall prevail.

INSTALLATION INSTRUCTIONS

Outdoor unit installation

Outdoor installation precaution

- Install the outdoor unit on a rigid base to prevent increasing noise level and vibration.
- Determine the air outlet direction where the discharged air is not blocked. In the case that the installation place is exposed to strong wind such as a seaside, make sure the fan operating properly by putting the unit lengthwise along the wall or using a dust or shield plates.
- Specially in windy area, install the unit to prevent the admission of wind. If need suspending installation, the installation bracket should accord with technique requirement in the installation bracket diagram.
- The installation wall should be solid brick, concrete or the same intensity construction, or actions to reinforce, damping supporting should be taken. The connection between bracket and wall, bracket and the air conditioner should be firm, stable and reliable.
- Be sure there is no obstacle which block radiating air.

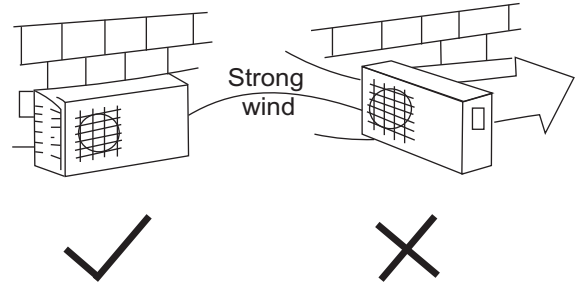

Fig.51

Settlement of outdoor unit

- Anchor the outdoor unit with a bolt and nut $\phi 10$ or $\phi 8$ tightly and horizontally on a concrete or rigid mount.

Outdoor unit dimension mm(L1xHxW1)	Mounting dimensions	
	L2(mm)	W2(mm)
760x590x285	530	290
845x700x320	560	335
900x860x315	590	333
990x965x345	624	366

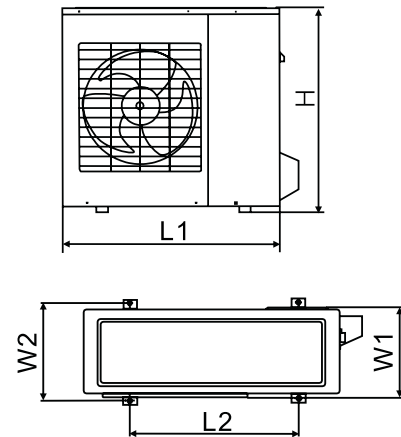

Fig.52

REFRIGERANT PIPE CONNECTION

Drain joint installation

NOTE: The drain joint differ from appliance to appliance.

Fit the seal into the drain joint, then insert the drain joint into the base pan hole of outdoor unit, rotate 90° to securely assemble them. Connecting the drain joint with an extension drain hose (Locally purchased), in case of the water draining off the outdoor unit during the heating mode.

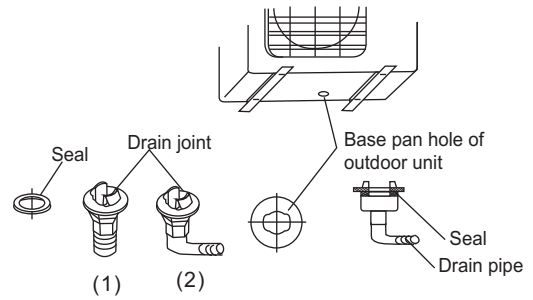

Fig.53

Refrigerant pipe connection

1. Flaring work

Main cause for refrigerant leakage is due to defect in the flaring work. Carry out correct flaring work using the following procedure:

A: Cut the pipes and the cable.

1. Use the piping kit accessory or pipes purchased locally.
2. Measure the distance between the indoor and the outdoor unit.
3. Cut the pipes a little longer than the measured distance.
4. Cut the cable 1.5m longer than the pipe length.

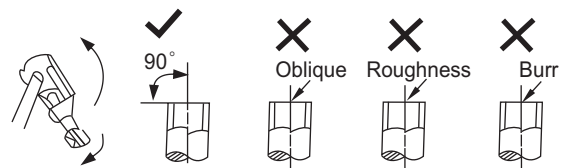

Fig.54

B: Burr removal

1. Completely remove all burrs from the cut cross section of pipe/tube.
2. Put the end of the copper tube/pipe in a downward direction as you remove burrs in order to avoid dropping burrs into the tubing.

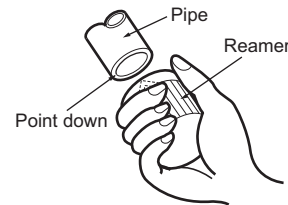

Fig.55

C: Putting nut on

Remove flare nuts attached to indoor and outdoor unit, then put them on pipe/tube having completed burr removal. (not possible to put them on after flaring work)

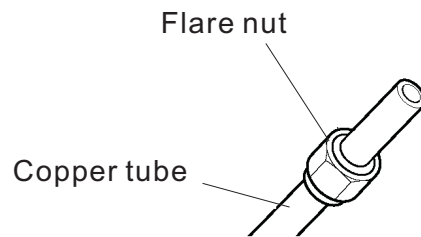

Fig.56

D: Flaring work

Firmly hold copper pipe in a die in the dimension shown in the table below.

Outer diam. (mm)	A(mm)	
	Max.	Min.
φ 6.35	1.3	0.7
φ 9.52	1.6	1.0
φ 12.7	1.8	1.0

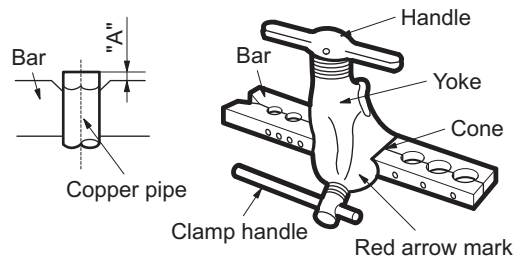

Fig.57

ELECTRICAL WORK

Tightening Connection

- Align the center of the pipes.
- Sufficiently tighten the flare nut with fingers, and then tighten it with a spanner and torque wrench as shown in Fig.58 & 59

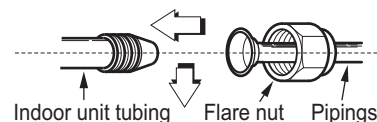

Fig.58

Outer diam.	Tightening torque(N.cm)	Additional tightening torque(N.cm)
φ 6.35	1500 (153kgf.cm)	1600 (163kgf.cm)
φ 9.52	2500 (255kgf.cm)	2600 (265kgf.cm)
φ 12.7	3500 (357kgf.cm)	3600 (367kgf.cm)

Caution

- Excessive torque can break nut depending on installation conditions.

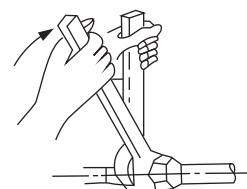

Fig.59

When select a 24K indoor unit

When select a 24K indoor unit, the manifold assembly (not supplied) should be purchased and installed together.

Installation method: when connecting the pipe, connect the liquid pipe (thin pipe) and gas pipe (thick pipe) of the manifold assembly to the high pressure valve and low pressure valve of the outdoor unit as identified with their respective matched numbers A & B, as shown below.

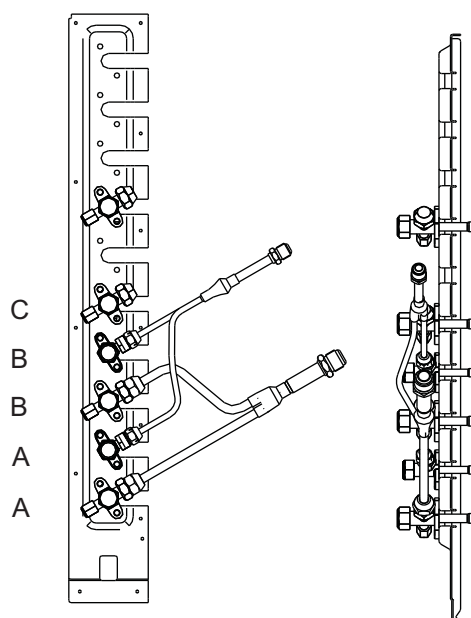

Fig.60

Electrical work

Electric safety regulations for the initial Installation

1. If there is serious safety problem about the power supply, the technicians should refuse to install the air conditioner and explain to the client until the problem is solved.
2. Power voltage should be in the range of 90%~110% of rated voltage.
3. The creepage protector and main power switch with a 1.5 times capacity of Max. Current of the unit should be installed in power circuit.
4. Ensure the air conditioner is grounded well.
5. According to the attached Electrical Connection Diagram located on the panel of the outdoor unit to connect the wire.
6. All wiring must comply with local and national electrical codes and be installed by qualified and skilled electricians.
7. An individual branch circuit and single receptacle used only for this air conditioner must be available.

Wiring connection

NOTE: Before performing any electrical work, turn off the main power to the system.



CAUTIONS

- Do not touch the capacitor even if you have disconnected the power for there is still high voltage power on it, or electric shock hazard may occur. For your safety, you should start repairing at least 5 minutes later after the power is disconnected.
- The power is supplied from the Outdoor Unit. The Indoor Units are connected with signal wires or power cords are connected reliably and correctly, or the air conditioner could not run normally.

NOTE:

The cable size and the current of the fuse or switch are determined by the maximum current indicated on the nameplate which is located on the side panel of the unit. Please refer to the nameplate before selecting the cable, fuse and switch. Please refer to the above tables and choose the proper wire size under the local electrical requirements.

Connect the cable to the outdoor unit

- Remove the electrical control board cover from the outdoor unit by loosening the screw as shown in Fig.61
- Connect the connective cables to the terminals as identified with their respective matched numbers on the terminal block of indoor and outdoor units.
- Secure the cable onto the control board with the cord clamp.
- To prevent the ingress of water, form a loop of the connective cable as illustrated in the installation diagram of indoor and outdoor units.
- Insulate unused cords (conductors) with PVC-tape. Process them so they do not touch any electrical or metal parts.



CAUTIONS

Make sure to connect the indoor unit (A, B, C, D, E) to the Hi and Lo valve and terminals of signal wires (A, B, C, D, E) of outdoor unit as identified with their respective matched connection. Wrong wiring connections may cause some electrical parts to malfunction.

Minimum nominal cross-sectional area of conductors:

Rated current of appliance (A)	Nominal cross-sectional area (mm ²)
>3 and ≤6	0.75
>6 and ≤10	1
>10 and ≤16	1.5
>16 and ≤25	2.5

Suggest Minimum Wire Size (AWG: American Wire Gauge):

Appliance Amps	AWG Wire Size
10	18
13	16
18	14
25	12
30	10

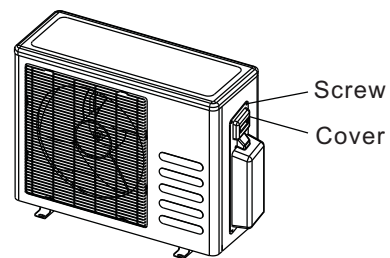

Fig.61

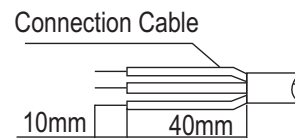
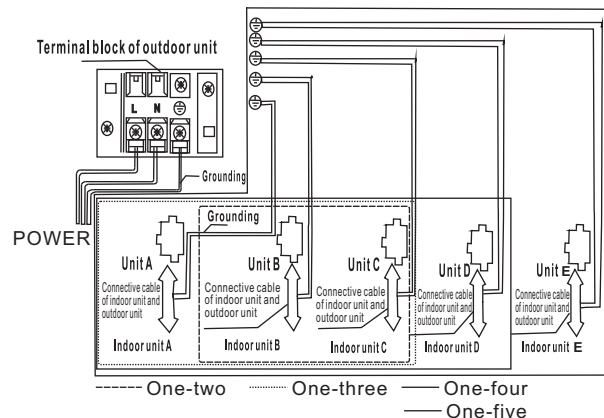

Fig.62



ELECTRICAL WORK

NOTE: please refer to the following figures, if the client want wire by themselves.

One-two models:

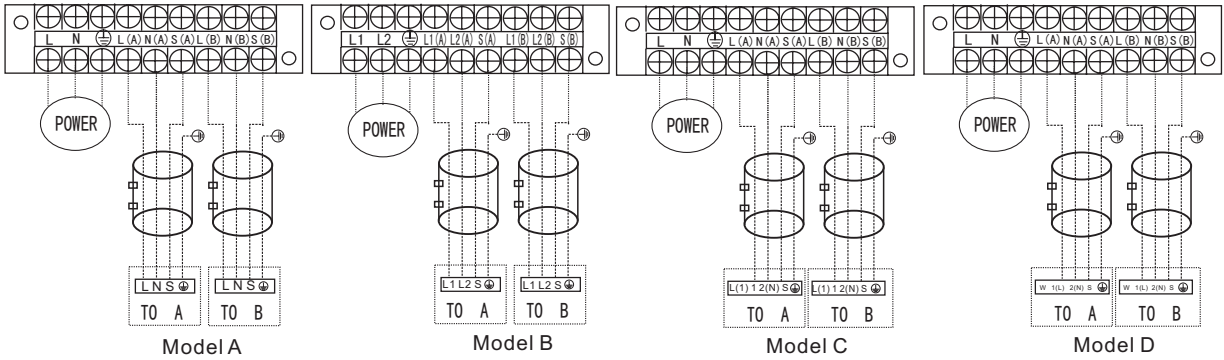

One-three models:

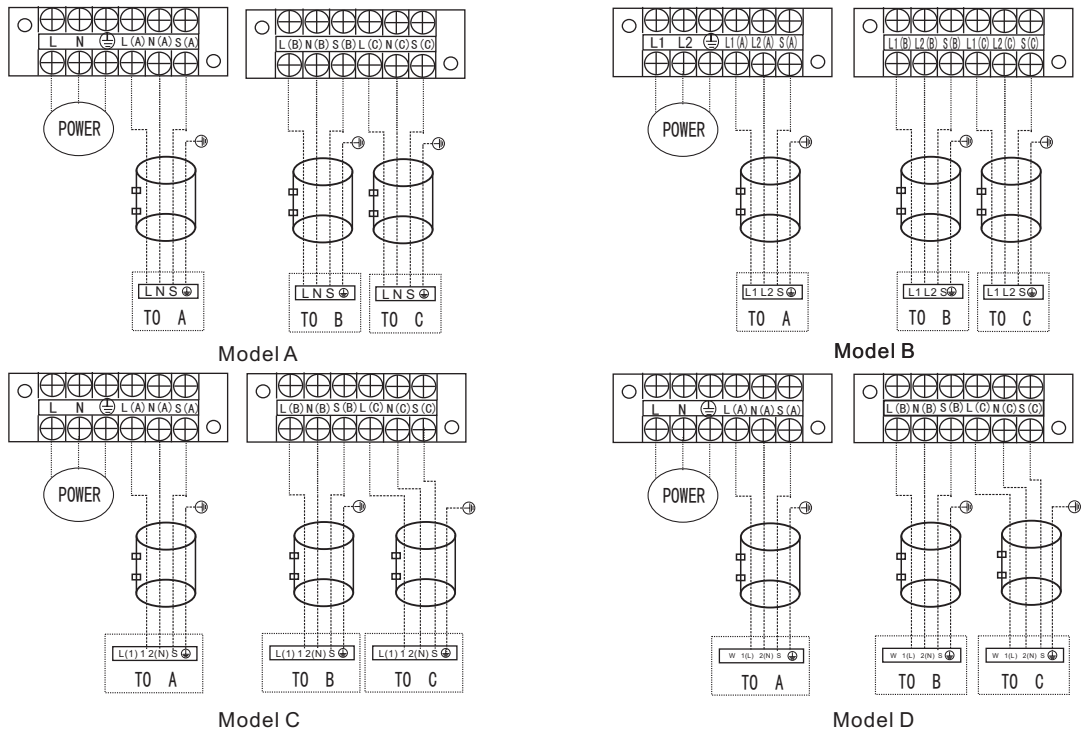

One-four models:

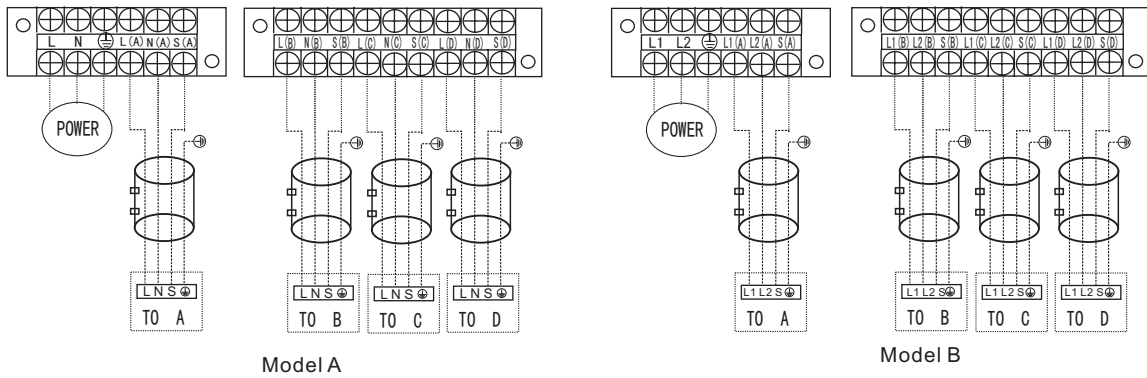

ELECTRICAL WORK

NOTE: please refer to the following figures, if the client want wire by themselves.

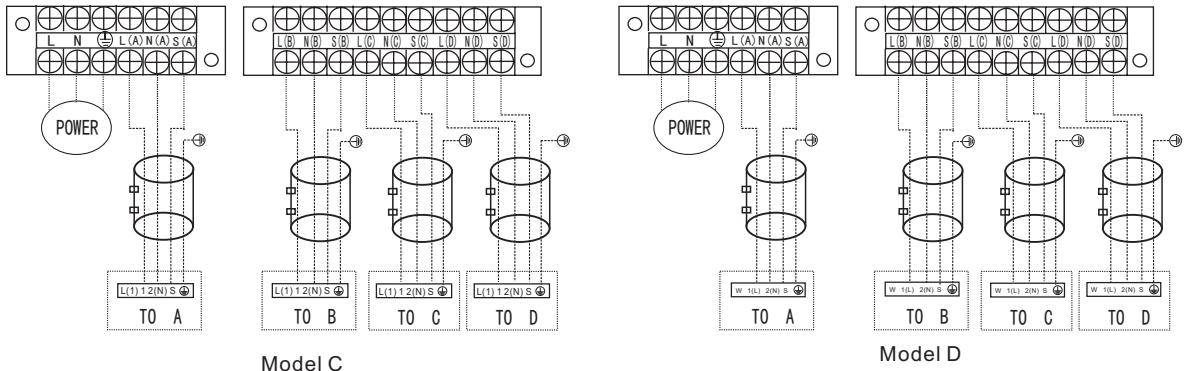

One-five models:

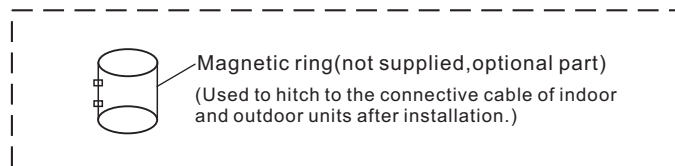
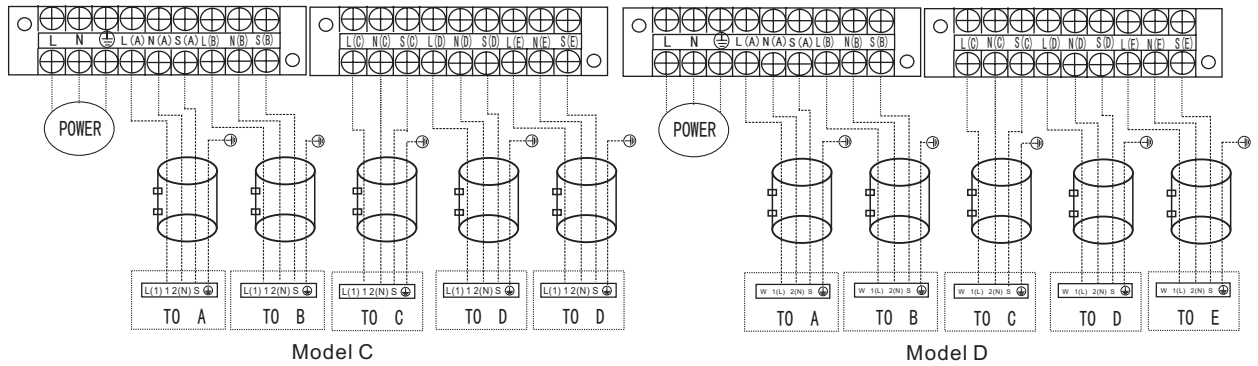
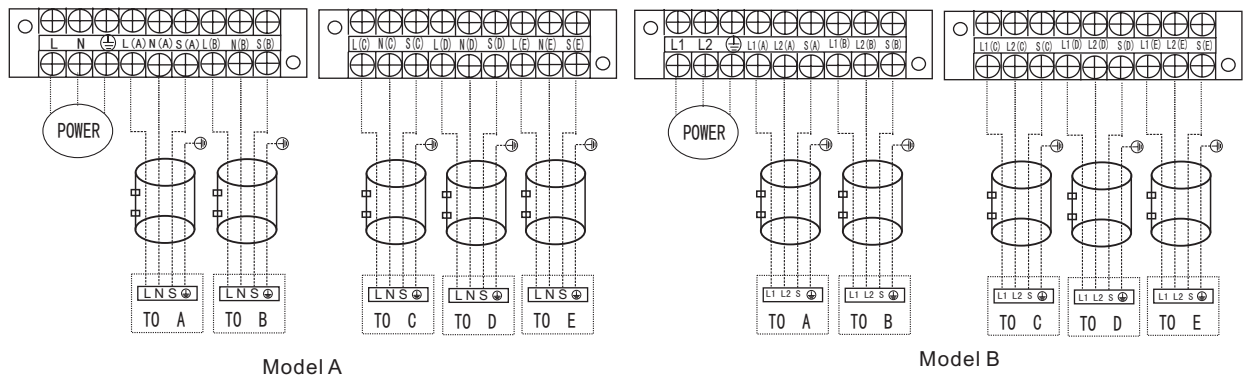

Fig.63

ELECTRICAL WORK

While connecting the wire of 24K model

While connecting the wire of 24K model, only the terminals A can be connected to the 24K indoor unit, at this time, the terminals B can not be connected to any indoor unit as shown below:

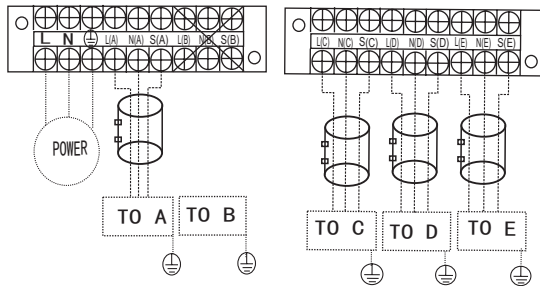

Fig.64

NOTE: When "EE" appeared in the indoor unit display window ("E9" appeared on the outdoor unit digital display at the same time), It indicates the wrong connection of 24K unit. It may be caused by the following conditions:

1. The terminals B is connected to any indoor unit, When the terminals A is already connected to 24K indoor unit.
2. Any one terminal of B, C, D, E is connected to 24K indoor unit.

CAUTION

After the confirmation of the above conditions, prepare the wiring as follows:

- 1) Never fail to have an individual power circuit specifically for the air conditioner. As for the method of wiring, be guided by the circuit diagram posted on the inside of control cover.
- 2) The screw which fasten the wiring in the casing of electrical fittings are liable to come loose from vibrations to which the unit is subjected during the course of transportation. Check them and make sure that they are all tightly fastened. (If they are loose, it could cause burn-out of the wires.)
- 3) Specification of power source.
- 4) Confirm that electrical capacity is sufficient.
- 5) See to that the starting voltage is maintained at more than 90 percent of the rated voltage marked on the name plate.
- 6) Confirm that the cable thickness is as specified in the power source specification.
- 7) Always install an earth leakage circuit breaker in a wet or moist area.
- 8) The following would be caused by voltage drop.
Vibration of a magnetic switch, which will damage the contact point, fuse breaking, disturbance of the normal function of the overload.
- 9) The means for disconnection from a power supply shall be incorporated in the fixed wiring and have an air gap contact separation of at least 3mm in each active(phase) conductors.
- 10) Before obtaining access to terminals, all supply circuits must be disconnected.

Air purging

Air and moisture in the refrigerant system have undesirable effects as indicated below:

- Pressure in the system rises.
- Operating current rises.
- Cooling or heating efficiency drops.
- Moisture in the refrigerant circuit may freeze and block capillary tubing.
- Water may lead to corrosion of parts in the refrigeration system.

Therefore, the indoor unit and tubing between the indoor and outdoor unit must be leak tested and evacuated to remove any noncondensables and moisture from the system.

Air purging with vacuum pump

- Preparation
Check that each tube (both liquid and gas side tubes) between the indoor and outdoor units have been properly connected and all wiring for the test run has been completed. Remove the service valve caps from both the gas and the liquid side on the outdoor unit. Note that both the liquid and the gas side service valves on the outdoor unit are kept closed at this stage.
- Pipe length and refrigerant amount:

Connective pipe length	Air purging method	Additional amount of refrigerant to be charged
Less than (5xN)m	Use vacuum pump.	_____
More than (5xN)m	Use vacuum pump.	Liquid side: ϕ 6.35 R410A: (Total pipe length - 5xN)x15g/m, N=2,3,4 or 5. Liquid side: ϕ 9.52 R410A: (Total pipe length - 5xN)x30g/m, N=2,3,4 or 5.

- When relocate the unit to another place, perform evacuation using vacuum pump.
- Make sure the refrigerant added into the air conditioner is liquid form in any case.

Caution in handling the packed valve

- Open the valve stem until it hits against the stopper. Do not try to open it further.
- Securely tighten the valve stem cap with a spanner or the like.
- Valve stem cap tightening torque (See Tightening torque table in previous page).

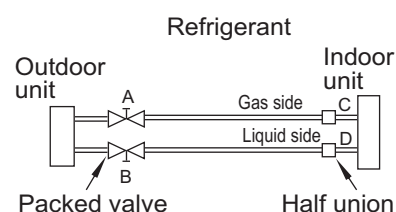

Fig.65

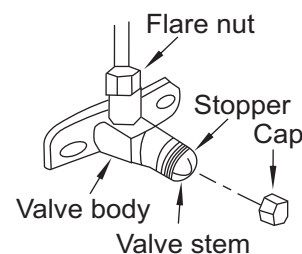

Fig.66

AIR PURGING

When Using the Vacuum Pump

(For method of using a manifold valve, refer to its operation manual.)

1. Completely tighten the flare nuts, A, B, C, D, connect the manifold valve charge hose to a charge port of the low-pressure valve on the gas pipe side.
2. Connect the charge hose connection to the vacuum pump.
3. Fully open the handle Lo of the manifold valve.
4. Operate the vacuum pump to evacuate. After starting evacuation, slightly loose the flare nut of the Lo valve on the gas pipe side and check that the air is entering (Operation noise of the vacuum pump changes and a compound meter indicates 0 instead of minus)
5. After the evacuation is complete, fully close the handle Lo of the manifold valve and stop the operation of the vacuum pump. Make evacuation for 15 minutes or more and check that the compound meter indicates -76cmHg ($-1 \times 10^5 \text{Pa}$).
6. Turn the stem of the packed valve B about 45° counterclockwise for 6~7 seconds after the gas coming out, then tighten the flare nut again. Make sure the pressure display in the pressure indicator is a little higher than the atmosphere pressure.
7. Remove the charge hose from the Low pressure charge hose.
8. Fully open the packed valve stems B and A.
9. Securely tighten the cap of the packed valve.

Safety and leakage check

● Electrical safety check

Perform the electric safe check after completing installation:

1. Insulated resistance
The insulated resistance must be more than $2\text{M}\Omega$.
2. Grounding work
After finishing grounding work, measure the grounding resistance by visual detection and grounding resistance tester. Make sure the grounding resistance is less than 4Ω .
3. Electrical leakage check (performing during test running)
During test operation after finishing installation, the serviceman can use the electroprobe and multimeter to perform the electrical leakage check. Turn off the unit immediately if leakage happens. Check and find out the solution ways till the unit operate properly.

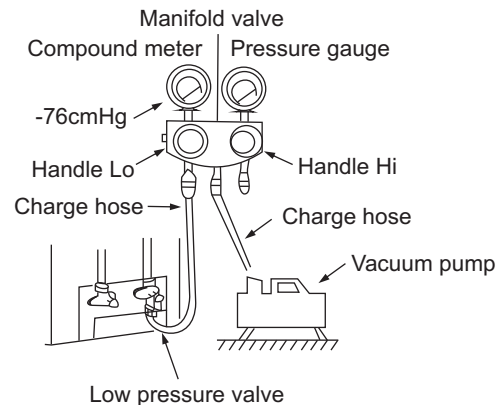

Fig.67

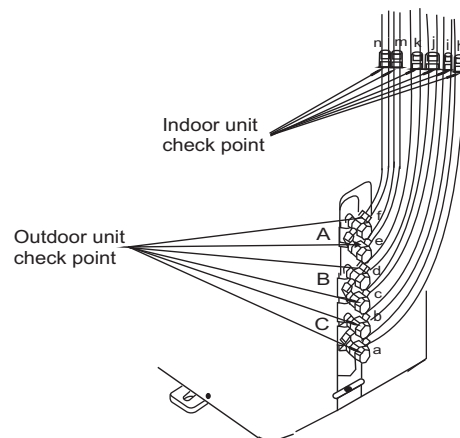

Fig.68

TEST RUNNING

● Gas leak check

1. Soap water method:

Apply a soap water or a liquid neutral detergent on the indoor unit connection or outdoor unit connections by a soft brush to check for leakage of the connecting points of the piping. If bubbles come out, the pipes have leakage.

2. Leak detector

Use the leak detector to check for leakage.

CAUTION

A: Lo packed valve B: Hi packed valve
C and D are ends of indoor unit connection.

NOTE: The illustration is for explanation purpose only. The actual order of A, B, C, D and E on the machine may be slightly different from the unit you purchased. The actual shape shall prevail.

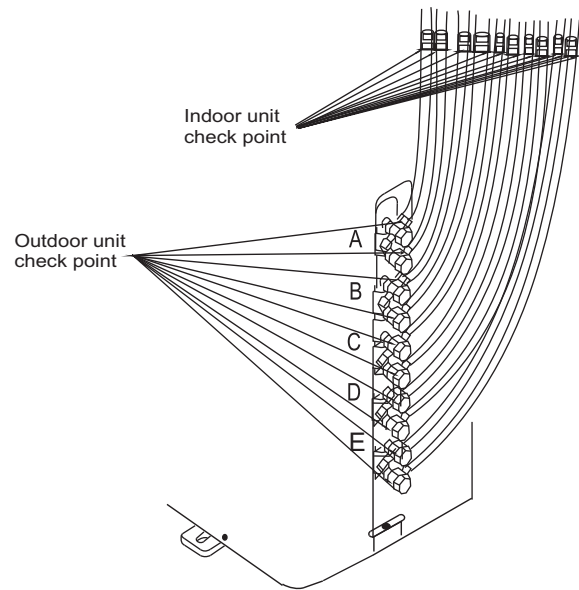

A, B, C, D are points for one-four type.
A, B, C, D, E are points for one-five type.

Fig.69

Test running

Perform test operation after completing gas leak check at the flare nut connections and electrical safety check.

- Check that all tubing and wiring have been properly connected.
 - Check that the gas and liquid side service valves are fully open.
1. Connect the power, press the ON/OFF button on the remote controller to turn the unit on.
 2. Use the MODE button to select COOL, HEAT, AUTO and FAN to check if all the functions works well.
 3. When the ambient temperature is too low (lower than 17°C), the unit cannot be controlled by the remote controller to run at cooling mode, manual operation can be taken. Manual operation is used only when the remote controller is disable or maintenance necessary.
 - Hold the panel sides and lift the panel up to an angle until it remains fixed with a clicking sound.
 - Press the Manual control button to select the AUTO or COOL, the unit will operate under Forced AUTO or COOL mode (see User Manual for details).
 4. The test operation should last about 30 minutes.

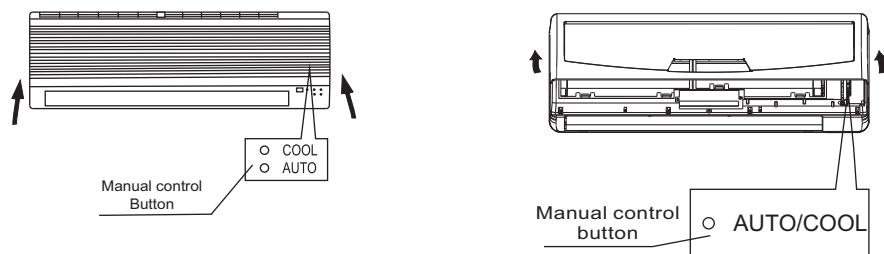

Fig.70

The design and specifications are subject to change without prior notice for product improvement. Consult with the sales agency or manufacturer for details.

CS464-I
202000191053
20131115