

KlimaIRE®

OWNER'S MANUAL

Models: KSIB018-H2161
KSIB024-H2161

Thank you for choosing KlimaIRE air conditioner, please read this owner's manual carefully before operating this unit and keep it carefully for consultation

◆ CONTENTS

Operation and maintenance

■ Notices for operation	1
■ Notices for use	3
■ Names and functions of each part	5
■ Operation of wireless remote control	6
■ Emergency operation	11
■ Clean and care	12
■ Troubleshooting	14

Installation service

■ Notices for installation	17
■ Installation dimension diagram	19
■ Install indoor unit	20
■ Install outdoor unit	22
■ Check after installation and test operation	23
■ Installation and Maintenance of Healthy Filter	24



This symbol stands for the items should be forbidden.



This symbol stands for the items should be followed

Thank you for choosing Klimaire air conditioner, please read this owner's manual carefully before operating the unit and keep it carefully for consultation.

The products in this manual may be different with the real one, according to different models, some models have displayer and some models without displayer, the position and shape of the displayer please refer to the real one.

This appliance is not intended for use by persons (including children) with reduced physiced, sensory or mental capabilities or lack of experience and knowledge, unless they have been given supervision or instruction concerning use of the appliance by a person responsible for their safety.





Children should be supervised to ensure that they do not play with the appliance.

Installation must be performed in accordance with the NEC/CEC by authorized person only.

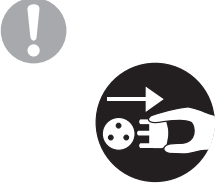

Do not dispose this product as unsorted municipal waste. Collection of such waste separately for special treatment is necessary.

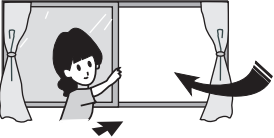
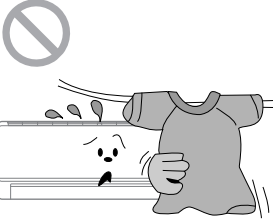
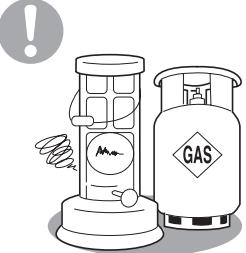
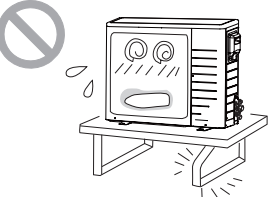
◆ Operation and maintenance-notice for operation

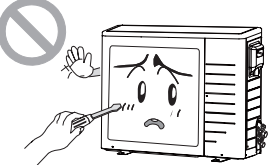
<p>⚠ ★ Earth: The ground be connected!</p>  <p>If not, please ask the qualified personnel to install. Furthermore, don't connect each wire to the gas pipe, water pipe, drainage pipe or any other improper places.</p>	<p>★ Be sure to pull out the power plug when not using the air conditioner for a long time.</p>  <p>Otherwise, the accumulated dust may cause fire or electric shock.</p>	<p>★ Select the most appropriate temperature.</p>  <p>It can preclude the electricity wasted.</p>
<p>★ Don't leave windows and doors open for a long time while operating the air conditioner.</p>  <p>It can decrease the air conditioning capacity.</p>	<p>★ Don't block the air intake or outlet vents of both the outdoor and indoor units.</p>  <p>It can decrease the air conditioning capacity or cause a malfunction.</p>	<p>★ Keep combustible spray away from the units more than 1m.</p>  <p>It can cause a fire or explosion.</p>
<p>★ Please note whether the installed stand is firm enough or not.</p>  <p>If it is damaged, it may lead to the fall of the unit and cause injury.</p>	<p>★ Don't step on the top of the outdoor unit or place something on it.</p>  <p>As falling off the outdoor unit can be dangerous.</p>	<p>★ Don't attempt to repair the air conditioner by yourself.</p>  <p>The wrong repair will lead to an electric shock or fire, so you should contact the service center to repair.</p>

◆ Notices for operation

- ★ If the supply cord is damaged, it must be replaced by the manufacturer or its service agent or a similarly qualified person in order to avoid a hazard.



- ★ The airflow direction can be adjusted appropriately. At operating, adjust the vertical airflow direction by adjusting the louvers of upward/downward direction. And then, hold two ends of left and right louver to adjust the horizontal airflow.

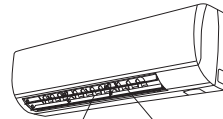

Louver of left/right direction Louver of upward/downward direction.

- ★ Don't insert your hands or stick into the air intake or outlet vents.



Otherwise it will cause accident.

- ★ Don't blow the wind to animals and plants directly. It can cause a bad influence to them.

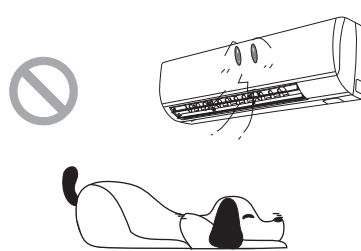

- ★ Don't apply the cold wind to the body for a long time.

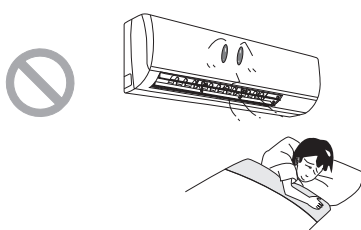

It can cause the health problems.

- ★ Don't use the air conditioner for other purposes, such as drying clothes, preserving foods, etc.



- ★ Splashing water on the air conditioner can cause an electric shock and malfunction.

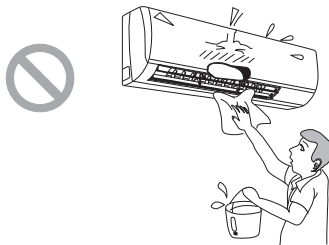

- ★ Don't place a space heater near the air conditioner.

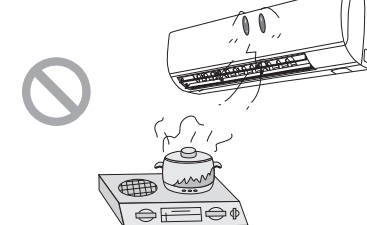

Or CO toxicosis may occur for incomplete burning.

◆ Notices for use

Working principle and special functions for cooling

Principle:

Air conditioner absorbs heat in the room and transmit to outdoor and discharged, so that indoor ambient temperature decreased, its cooling capacity will increase or decrease by outdoor ambient temperature.

Anti-freezing function:

If the unit is running in COOL mode and in low temperature, there will be frost formed on the heat exchanger, when indoor heat exchanger temperature decreased below 0°C, the indoor unit microcomputer will stop compressor running and protect the unit.

Working principle and special functions for heating

Principle:

- * Air conditioner absorbs heat from outdoor and transmits to indoor, in this way to increase room temperature. This is the heat pump heating principle, its heating capacity will be reduced due to outdoor temperature decrease.
- * If outdoor temperature becomes very low, please operate with other heating equipments.

Defrosting:

- * When outdoor temperature is low but high humidity, after a long while running, frost will form on outdoor unit, that will effect the heating effect, at this time, the auto defrosting function will act, the heat running will stop for 8-10mins.
- * During the auto defrosting, the fan motors of indoor unit and outdoor unit will stop.
- * During the defrosting, the indoor indicator flashes, the outdoor unit may emit vapor. This is due to the defrosting, it isn't malfunction.
- * After defrosting finished, the heating will recover automatically.

Anti-cool wind function:

In "Heat" mode, under the following three kinds of state, if indoor heat exchanger doesn't arrive at certain temp., indoor fan will not act, in order to prevent cool wind blowing(within 2 mins):

1. Heating starts.
2. After Auto Defrost finished.
3. Heating under the low temperature.

◆ Notices for use

※ Working temperature range		
	Indoor sideDB/WB(°C)	Outdoor sideDB/WB(°C)
Maximum cooling	32/23	48/-
Minimum cooling	21/15	10/-
Maximum heating	27/-	24/18
Minimum heating	20/-	-15/--

The operating temperature range (outdoor temperature) for cooling unit is 10°C ~ 48°C ;
for cooling and heating unit is -15°C ~ 48°C.

◆ Names and functions of each part

Indoor unit

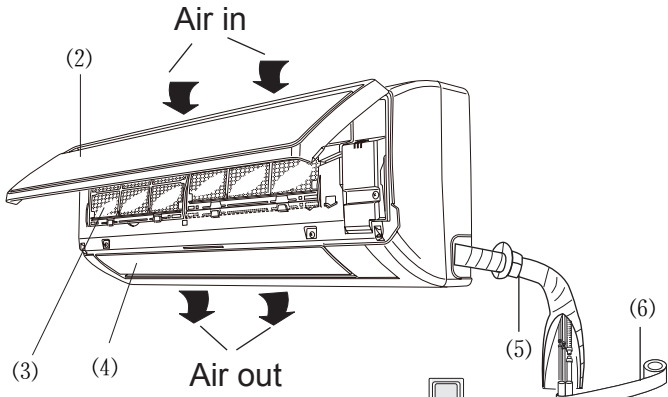

SET TEMP/ 88
 AMBIENT TEMP

- Cool — — — Dry
- Heat — — — Power
- ON/OFF — — Receive window

Outdoor unit

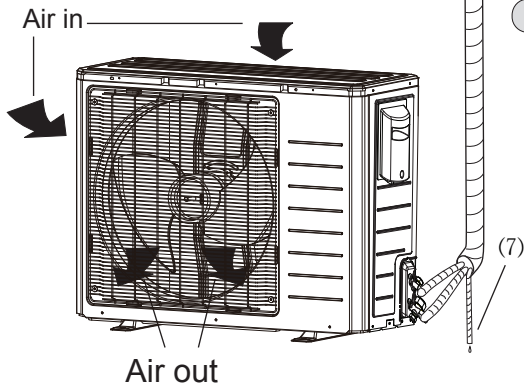

- (1) Remote control
- (2) Front panel
- (3) Filter
- (4) Guide louver
- (5) Wall pipe
- (6) Bind tape
- (7) Drainage pipe

This is just the schematic plan, please refer to the actual product.

◆ Operation of remote control

Names and functions of remote control buttons

Note: Be sure that there are no obstructions between receiver and remote control; Don't drop or throw the remote control; Don't let any liquid in the remote control and put the remote control directly under the sunlight or any place where is very hot.

Signal transmitter

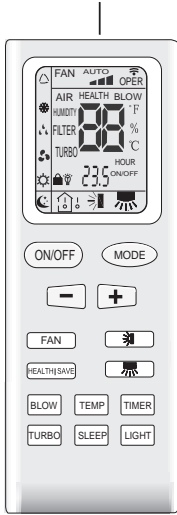

Remote control

ON/OFF

ON/OFF button

- Press this button, the unit will be started or stopped, which can clear the timer or sleeping function of last time.

MODE

Mode button

- Press this button, the running mode will change as below.



△ AUTO

❄ COOL

🔥 DRY

🌀 FAN

☀ HEAT (Note: no for cooling only unit)

(+/-)

TEMP. (+/-) button

- When press +button, the setting temp. will be increased by 1°C, When press -button, the setting temp. will be decreased by 1°C. The temp. will be changed quickly by pressing the button continuously and setting temp. range is 16~30°C。(63°F~86°F).

FAN

FAN speed button

- Press this button once, fan speed will change as below:



▮ Low speed ▮▮ Middle speed

▮▮▮ High speed

- Note: Under the Dry mode, the fan speed isn't adjustable, low fan speed is imperative, but when operating this button, the wireless remote control will send this signal.



Swing up and down button

- Simplesness swing mode is defaulted for wireless remote control, in this mode, press this button, could turn on or turn off the Up and down swing function.
- When unit is turned off, synchronously press "+" and Up and down swing buttons, it could be switched between the simplessness swing mode and stationary swing mode, at this time,  blinks 2 seconds.

- In Stationary swing mode, press this button, the angle for Up and down swing as show in below:

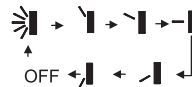

- When up and down swing louver is working, when turn off the unit, the siwng louver will immediately stop at current position.  shows up and down swing louver swings back and forth as show in the above figure.

◆ Operation of remote control

Names and functions of remote control buttons

NOTE: This Remote control is universal, it could be used for many units, some buttons of this control which are not available to this unit will not be described below.



Remote control

HEALTH|SAVE

HEALTH| SAVE button

- HEALTH function: there is no this function for this unit. If press this key, the main unit will click, but it also runs under original status.
- Save energy function: Under Cool mode, press the right part of this button, the remote control will display "SE", the whole unit will enter into "Electricity Save mode", repress this button, the whole unit will quit this mode, other mode button is not available. Under the Energy Save mode, the Temperature and the Fan speed on the remote control are not adjustable.

TURBO

Turbo button

- Set turbo on or off (the characters of turbo will appear or disappear) by pressing this key under cooling or heating mode. Once energized, the unit will be defaulted to be turbo off. This function can not be set under auto, dehumidify or fan mode, and characters of turbo won't appear.

TIMER

Timer button

- On the status of the unit on, press this button to set timer off. On the status of the unit off, press this button to set timer off. Press this key once, words Hour on/off will appear and flicker. In which case, press +/- button to adjust time (press +/- button continuously to change timing value quickly), the setting time range is from 0.5 to 24 hr.; press this key once again to fix the time, then remote controller will send out the signal immediately and hour on/off will stop flickering. If the time of that no press timer button under flickering status is above 5s, the timer setting will quit. If the timer has been set, press this button once again to quit it.



Left and right swing button

- There is no this function for this unit. If press this key, the main unit will click, but it also runs under original status.

◆ Operation of remote control

Names and functions of remote control buttons

NOTE: This remote control is universal, it could be used for many units, some buttons of this control which are not available to this unit will not be described below.

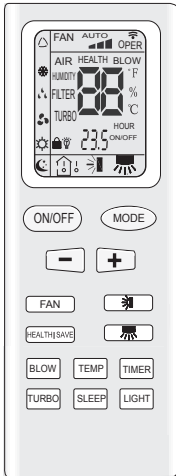

Remote control



BLOW

BLOW

- Set Blow on (the characters of Blow will appear) or off (the characters of Blow disappear) by pressing this key under cool or DRY mode. Once energized, the unit will be defaulted to be Blow off. This function can not be set under auto, fan or heat mode, and the characters of Blow won't appear.

LIGHT

Light button

- Press this button to select LIGHT on or off in the display. When the LIGHT on is set, the icon  will be displayed and the indicator light in the display will be on. When the LIGHT off is set, the icon  will be displayed and the indicator light in the display will be off.

TEMP

TEMP button

- Press this button, could select displaying the indoor setting temperature or indoor ambient temperature. When the indoor unit firstly power on it will display the setting temperature, if the temperature's displaying status is changed from other status to "", displays the ambient temperature, 5s later or within 5s, it receives other remote control signal that will return to display the setting temperature. if the users haven't set up the temperature displaying status, that will display the setting temperature.

SLEEP

Sleep button

- Press this button, Sleep On and Sleep Off can be selected. After powered on, Sleep Off is defaulted. After the unit is turned off, the Sleep function is canceled. After Sleep function set up, the signal of Sleep will display. In this mode, the time of timer can be adjusted. Under Fan and Auto modes, this function is not available. In sleep mode, setting temperature is adjusted automatically.

◆ Operation of remote control

Guide for operation-general operation

1. Press ON/OFF button to start the unit after powering the main unit on. (Note: Power the unit on every time, the big -guide louver and small-guide louver will be closed firstly.)
2. Press MODE button to select desired running mode.
3. Press +/- button to set the desired temperature. (It is unnecessary to set the temperature at AUTO mode)
4. Press FAN button to set fan speed, the AUTO FAN, LOW, MID or HIGH could be selected.
5. Press  button to set swing mode.

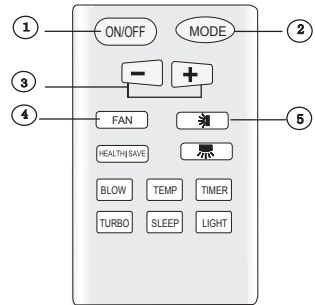

Guide for operation-optional operation

1. Press SLEEP button, set the sleep mode.
2. Press TIMER button, then press +/- button, to set the scheduled timer on or timer off.
3. Press light button to control displayer light on or off.
4. Press Blow button to set Blow function on or off.
5. Press turbo button to set this function on or off.

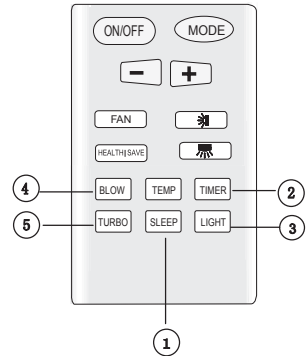

Introduction for special function

★ About blow function

This function indicates that moisture on evaporator of indoor unit will be blown after the unit is stopped to avoid mould.

1. Having set blow function on: After turning off the unit by pressing ON/OFF button indoor fan will continue running for about 10 min. at low speed. In this period, press blow button to stop indoor fan directly.
2. Having set blow function off: After turning off the unit by pressing ON/OFF button, the complete unit will be off directly.

◆ Operation of remote control

★ About AUTO RUN

When AUTO RUN mode is selected, the setting temperature will not be displayed on the LCD, the unit will be in accordance with the room temp. automatically to select the suitable running method and to make ambient comfortable.

★ About turbo function

If start this function, the unit will run at super-high fan speed to cool or heat quickly so that the ambient temp. approaches the preset temp. as soon as possible.

★ About lock

Press + and - buttons simultaneously to lock or unlock the keyboard. If the remote controller is locked, the icon  will be displayed on it, in which case, press any button, the mark will flicker for three times. If the keyboard is unlocked, the mark will disappear.

★ About switch between Fahrenheit and Centigrade

Under status of unit off, press MODE and - buttons simultaneously to switch °C and °F.

Changing batteries and notices

1. Slightly to press the place with , along the arrowhead direction to push the back cover of wireless remote control. (As show in figure)
2. Take out the old batteries. (As show in figure)
3. Insert two new AAA1.5V dry batteries, and pay attention to the polarity. (As show in figure)
4. Attach the back cover of wireless remote control. (As show in figure)

★ NOTE:

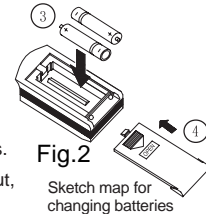
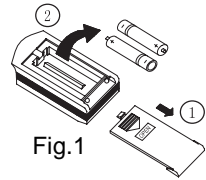

- When changing the batteries, do not use the old or different batteries, otherwise, it can cause the malfunction of the wireless remote control.
- If the wireless remote control will not be used for a long time, please take them out, and don't let the leakage liquid damage the wireless remote control.
- The operation should be in its receiving range.
- It should be placed at where is 1m away from the TV set or stereo sound sets.
- If the wireless remote control can not operate normally, please take them out, after 30s later and reinsert, if they cannot normally run, please change them.



◆ Emergency operation

Displayer indicator light control of indoor unit

It's a special selective button for the users, who are not accustomed to the light at sleeping.

- Get the displayer indicator light on: When setting the light function, the mark  will display on the remote controller screen by pressing this button. In which case, the displayer indicator light will be on if the AC receives this signal.
- Get the displayer indicator light off: If cancel the light function, the mark  will disappear on the remote controller screen by pressing this button. In which case, the displayer indicator light will be off if the AC receives this signal.

Emergency operation

If the wireless remote control is lost or broken, please use the manual switch button. At this time, the unit will run at the Auto mode, but the temperature and fan speed cannot be changed. The operation was shown as below:

To open the panel, the manual switch is on the displayer box.

- Turn on the unit: At unit turned off, press the button, the unit will run at Auto mode immediately. The microcomputer will accord to the indoor temperature to select (Cooling, Heating, Fan) and obtain the comfortable effect.
- Turn off the unit: At unit turned on, press the button, the unit will stop working.

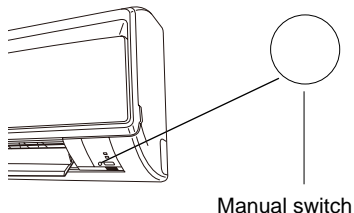

Fig.3

Clean and care



Caution

- Turn power off and pull out the power plug before cleaning air conditioner, or it may cause electric shock.
- Never sprinkle water on the indoor unit and the outdoor unit for cleaning because it can cause an electric shock.
- Volatile liquid (e.g. thinner or gasoline) will damage the air conditioner. (So wipe the units with a dry soft cloth, or a cloth slightly moistened with water or cleanser.)

Clean the front panel

When cleaning the front panel, please dip the cloth into the water temperature of 45°C below, then to dry the cloth and wipe the dirty part.

Note: Please do not to immerse the front panel in water, due to there are microcomputer components and circuit diagrams on the front panel.

Clean the air filter (Recommended once every three months)

NOTE: If dust is much more around the air conditioner, the air filters should be cleaned many times. After taking off the filter, don't touch the fin of indoor unit, in order to avoid hurt your fingers.

① Take down the air filter

At the slot of surface panel to open an angle, pull the air filter downward and take it out, please see the Fig. 4(a, b).

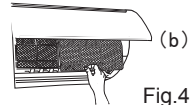
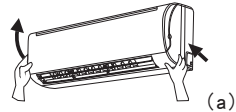
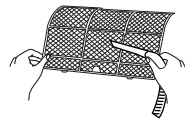

Fig.4

② Clean the air filter

To clean the dust adhering to the filters, you can either use a vacuum cleaner, or wash them with warm water the water with the neutral detergent should below 45 degree) ,and dry it in the shade.

NOTE: Never use water above 45°C to clean, or it can cause deformation or discoloration. Never parch it by fire, or can cause a fire or deformation.



③ Insert the air filter

Reinsert the filters along the direction of arrowhead, and then to cover the cover and clasp it.

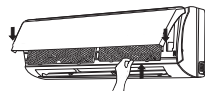

◆ Clean and care

Check before use

- ① Be sure that nothing obstructs the air outlet and intake vents.
- ② Check that whether ground wire is properly connected or not.
- ③ Check that whether the batteries of air conditioner are changed or not.
- ④ Check that whether the installation stand of the outdoor unit is damaged or not. If damaged, please contact the dealer.

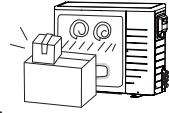

Maintain after use



- ① Turn main power off.
- ② Clean the filter and indoor and outdoor units' bodies.
- ③ Clear dust and obstructions from the outdoor unit.
- ④ Repaint the rubiginous place on the outdoor unit to prevent it from spreading.
- ⑤ Adopt the special shield to cover the outdoor unit, avoid the rain water, dust enter into the unit and get rust.

◆ Troubleshooting

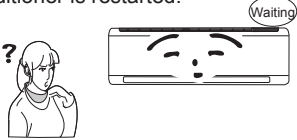
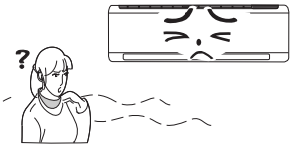
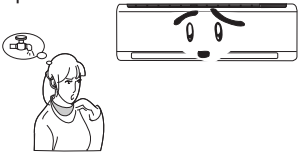

CAUTION

Don't attempt to repair the air conditioner by yourself, it can cause an electric shock or fire. Please check the following items before asking for repair, it can save your time and money.

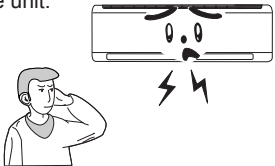
Phenomenon	Troubleshooting
<p>Not operate immediately when the air conditioner is restarted.</p> 	<ul style="list-style-type: none"> Once the air conditioner is stopped, it will not operate in approximately 3 minutes to protect itself.
<p>There's unusual smell blowing from the outlet after operation is started.</p> 	<ul style="list-style-type: none"> The unit has no peculiar smell by itself. If has, that is due to the smell accumulated in the ambient. Solution method: Cleaning the filter. If problem still has, so need to clean air conditioner. (Please contact with the authorized maintenance center.)
<p>Sound of water flow can be heard during the operation.</p> 	<ul style="list-style-type: none"> The air conditioner is started, when it is running the compressor started or stopped running, or the unit is stopped, sometimes there is swoosh or gurgle, the sound is due to refrigerant flowing they are not malfunctions.
<p>In COOL mode, sometimes the mist emitted from the air outlet vent.</p> 	<ul style="list-style-type: none"> When the indoor temperature and humidity are very high, this phenomenon would happen. This is caused by the room air is swiftly cooled down. After running for a while, indoor temperature and humidity will fall down, the mist will die away.
<p>Creaking noise can be heard when start or stop the unit.</p> 	<ul style="list-style-type: none"> This is caused by the deformation of plastic due to the changes of temperature.

◆ Troubleshooting

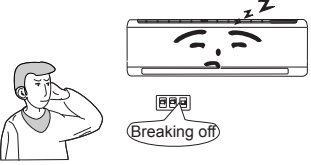
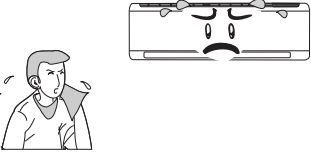
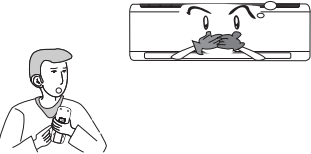
Phenomenon	Troubleshooting
<p>The unit can not run.</p> 	<ul style="list-style-type: none"> ● Has the power been shut down? ● Is power plug loosed? ● Is the circuit protection device tripped off or not? ● Is voltage higher or lower? (Tested by professionals) ● Is the TIMER correctly used?
<p>Cooling(Heating) efficiency is not good.</p> 	<ul style="list-style-type: none"> ● Is Temp. setting suitable? ● Were inlet and outlet vents obstructed? ● Is filter dirty? ● Are the windows and doors clothed? ● Did Fan speed set at low speed? ● Is there any heat sources in the room?
<p>Wireless remote control is not available.</p> 	<ul style="list-style-type: none"> ● The unit is interfered by abnormal or frequent functions switchover occasionally the controller cannot operate. At this time, you need to pull out of the plug, and reinsert it. ● Is it in its receiving range? Or obstructed? To check the voltage in wireless remote control inside is charged, otherwise to replace the batteries. ● Whether the wireless remote control is damaged.
<p>If water leakage in the room.</p>	<ul style="list-style-type: none"> ● The air humidity is on the high side. ● Condensing water over flowed. ● The connection position of indoor unit drainage pipe is loosed.
<p>If water leakage in outdoor unit.</p>	<ul style="list-style-type: none"> ● When the unit is running in COOL mode, the pipe and connection of pipe would be condensed due to the water cooled down. ● When the unit is running in Auto Defrosting mode the ice thawed and flowed out. ● When the unit is running in HEAT mode, the water adhered on heat exchanger dripped off.
<p>Noise from indoor unit emitted.</p>	<ul style="list-style-type: none"> ● The sound of fan or compressor relay is switching on or off. ● When the defrosting is started or stop running, it will sound. That is due to the refrigerant flowed to the reverse direction.

◆ Troubleshooting

Phenomenon	Troubleshooting
Indoor unit cannot deliver air.	<ul style="list-style-type: none"> ● In HEAT mode, when the temperature of indoor heat exchanger is very low, that will stop deliver air in order to prevent cool air. (Within 2min) ● In HEAT mode, when the outdoor temperature is low or high humidity, there are much frost be formed on the outdoor heat exchanger, that the unit will automatically defrost, indoor unit stop blowing air for 3-12min. During the defrosting, there is water flowing out or vapor be produced. ● In dehumidifying mode, sometimes indoor fan will stop, in order to avoid condensing water be vaporized again, restrain temperature rising.
Moisture on air outlet vent.	<ul style="list-style-type: none"> ● If unit is running under the high humidity for a long time, the moisture will be condensed on the air outlet grill and drip off.



Immediately stop all operations and plug out, contact the dealer in following situations.

There is harsh sound during operation.
 The terrible odors emitted during operation.
 Water is leaking in the room.
 Air switch or protection switch often breaks.
 Carelessly splash water or something into unit.
 There is an abnormal heat in power supply cord and power plug.

▶ Stop running and pull out of the plug.

◆ Notices for installation



Important Notices

1. The unit installation work must be done by qualified personnel according to the local rules and this manual.
2. Before installing, please contact with local authorized maintenance center, if unit is not installed by the authorized maintenance center, the malfunction may not solved, due to discommodious contacts.
3. When removing the unit to the other place, please firstly contact with the authorized Maintenance Center in the local area.
4. the appliance must be positioned so that the plug is accessible.

Basic Requirements For Installation Position

Install in the following place may cause malfunction. If it is unavoidable contact with service center please:

- Place where strong heat sources, vapors, flammable gas or volatile object are emitted.
- Place where high-frequency waves are generated by radio equipment, welders and medical equipment.
- Place where a lot of salinities such as coast exists.
- Place where the oil (machine oil) is contained in the air.
- Place where a sulfured gas such as the hot spring zones is generated.
- Other place with special circumstance.

Indoor Unit Installation Position Selection

1. The air inlet and outlet vent should be far from the obstruction, make sure that the air can be blown through the whole room.
2. Select a position where the condensing water can be easily drained out, and the place is easily connected for outdoor unit.
3. Select a location where the children can not reach.
4. Can select the place where is strong enough to withstand the full weight and vibration of the unit. And will not increase the noise.
5. Be sure to leave enough space to allow access for routine maintenance. The height of the installed location should be 250cm or more from the floor.
6. Select a place about 1m or more away from TVset or any other electric appliances.
7. Select a place where the filter can be easily taken out.
8. Make sure that the indoor unit installation should accord with installation dimension diagram requirements.
9. Do not use the unit in the immediate surroundings of a laundry a bath a shower or a swimming pool.

Outdoor Unit Installation Position Selection

1. Select a location from which noise and outflow air emitted by unit will not inconvenience neighbors, animals, plants.
2. Select a location where there should be sufficient ventilation.
3. Select a location where there should be no obstructions cover the inlet and outlet vent.
4. The location should be able to withstand the full weight and vibration of the outdoor unit and permit safe installation.
5. Select a dry place, but do not expose under the direct sunlight or strong wind.
6. Make sure that the outdoor unit installation dimension should accord with installation dimension diagram, convenient for maintenance, repair.
7. The height difference of connecting the tubing within 5m, the length of connecting the tubing within 10m.
8. Select a place where it is out of reach for the children.
9. Select a place where will not block the passage and do not influence the city appearance.

◆ Notices for installation

Safety Requirements For Electric Appliances

1. The power supply should be used the rated voltage and AC exclusive circuit, the power cable diameter should be satisfied.
2. Don't drag the power cable emphatically.
3. It should be reliably earthed, and it should be connected to the special earth device, the installation work should be operated by the professional.
The air switch must have the functions of magnetic tripping and heat tripping, in order to protect the short circuit and overloading.
4. The min. distance from the unit and combustive surface is 1.5m.
5. The appliance shall be installed in accordance with national wiring regulations.
6. An all-pole disconnection switch having a contact separation of at least 3mm in all poles should be connected in fixed wiring.

Note:

- Make sure that the Live wire or Zero line as well as the earth wire in the family power socket can not be wrong connected, there should be reliable and no short circuit in the diagram.
- wrong connection may cause fire.

Air-conditioner(Btu/h)	Air switch capacity
18、24K	25A

Earthing requirements

1. Air conditioner is type I electric appliance, thus please do conduct reliable earthing measure.
2. The yellow-green two-color wire in air conditioner is earthing wire and cannot be used for other propose. It cannot be cut off and be fix it by screw, otherwise it would cause electric shock.
3. The earth resistance should accord to the National Criterion.
4. The user power must offer the reliable earthing terminal. Please don't connect the earthing wire with the following place:
 - ① Tap water pipe.
 - ② Gas pipe.
 - ③ Contamination pipe.
 - ④ Other places that professional personnel consider them unreliable.
5. The model and rating values for fuses according the silk print on fuse cover or related PCB board.

◆ Installation dimension diagram

Installation dimension diagram

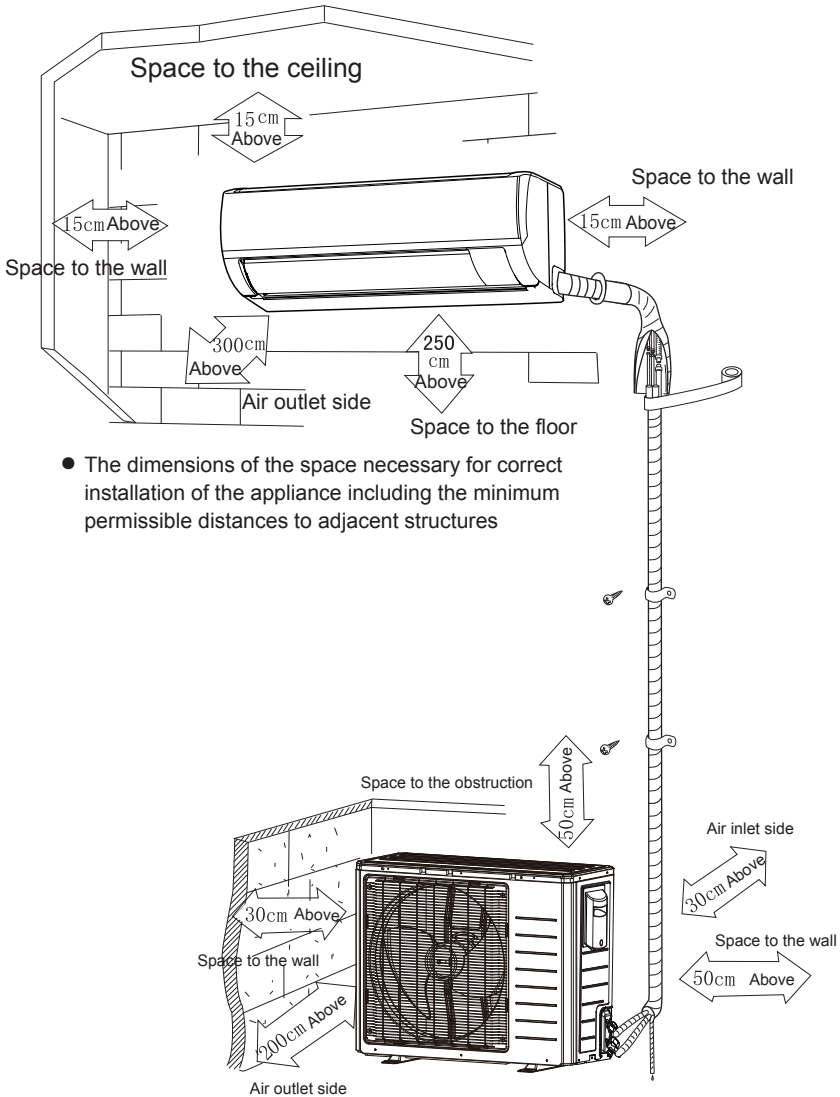

- The dimensions of the space necessary for correct installation of the appliance including the minimum permissible distances to adjacent structures

This is just the schematic plan, please refer to the actual product.

Install indoor unit

Install the rear panel

1. Always mount the rear panel horizontally. Due to the water tray of indoor unit has been adopted the both-way drainage design, the outlet of water tray should be adjusted slightly down when installing, that is taking the outlet of the water tray as the center of a circle, the included angle between the evaporator and level should be 0 or more, that is good for condensing water drainage.

2. Fix the rear panel on the wall with screws. (Where is pre-covered with plastic granula)

3. Be sure that the rear panel has been fixed firmly enough to withstand the weight of an adult of 60kg, further more, the weight should be evenly shared by each screw.

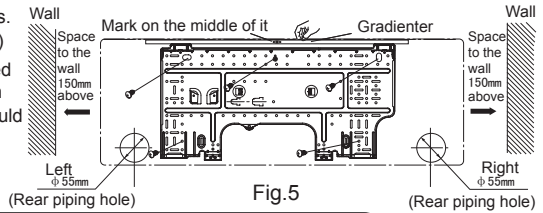

Install the piping hole

1. Make the piping hole ($\phi 55$) in the wall at a slight downward slant to the outdoor side.

2. Insert the piping-hole sleeve into the hole to prevent the connection piping and wiring from being damaged when passing through the hole.

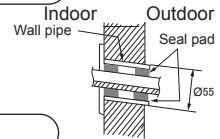

Install the water drainage pipe

1. For well draining, the drain hose should be placed at a downward slant.

2. Do not wrench or bend the drain hose or flood its end by water.

3. When the long drainage hose passing through indoor, should wrap the insulation materials.

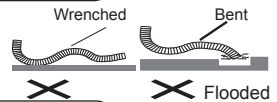

Wiring of indoor unit

Note: The power of indoor unit is supplied by the outdoors without installing electricity leakage breaker. But break switch should be installed.

Operation procedures:

1. Open the surface panel.
2. Open the cover and cover plate of electric box.
3. Remove the receiving window.
4. Wire pipe should be tightened by the fixed nut and the electric box should be fixed as shown in the above right figure and the below figure.

Notice before installation

- ① How to install the over line pipe (According to the direction as show.)



- ② Finish (According to the direction as show in right figure.)



◆ Install indoor unit

NOTE:

When connecting the electric wire if the wire length is not enough, please contact with the authorized service shop to buy a exclusive electric wire that is long enough and the joint on the wire are not allowed.

- The electric wiring must be correctly connected, wrong connection may cause spare parts malfunction.
- Tighten the terminal screw in order to prevent loose.
- After tighten the screw, slight pull the wire and confirm whether is it firm or not.
- If the earth wire is wrong connection, that may cause electric shock.
- The cover plate must be fixed, and tighten the connection wire, if it is poor installed, that the dust, moisture may enter in or the connection terminal will be affected by outside force, and will cause fire or electric shock.

Install the indoor unit

- The piping can be lead out from right, right rear, left left rear.
1. When routing the piping and wiring from the left or right side of indoor unit, cut off the tailings from the chassis in necessary(Show in Fig.7)
 - (1) Cut off the tailings 1 when routing the wiring only;
 - (2) Cut off the tailings 1 and tailings 2 when routing both the wiring and piping.
 2. Take out the piping from body case, wrap the piping electric wire, water pipe with tape and pull them through the piping hole (As show in Fig.8)
 3. Hange the mounting slots of the indoor unit on the upper tabs of the rear panel and check if it is firm enough.(As show in Fig.9)
 4. The height of the installed location should be 2.5m or more from the floor.

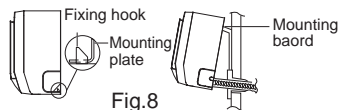
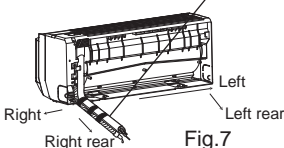
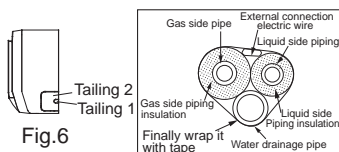

Install the connection pipe

1. Align the center of the piping flare with the relevant valve.
2. Screw in the flare nut by hand and then tighten the nut with spanner and torque wrench refer to the following:

Hex nut diameter	Tightening torque (N · m)
Φ6	15~20
Φ 9. 52	31~35
Φ 12	50~55
Φ 16	60~65
Φ 19	70~75

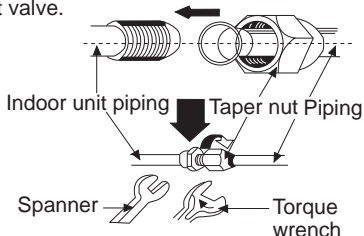

NOTE: Firstly connect the connection pipe to indoor unit, then to outdoor unit; pay attention to the piping bending, do not damage the connection pipe; the joint nut couldn't tighten too much, otherwise it may cause leakage.

◆ Install outdoor unit

Electric wiring

1. Disassemble the handle on the outdoor unit right side plate.
2. Take off cord anchorage. Connect and fix power connect cord (for cooling and heating unit, connect and fix power connect cord and signal control wire) to terminal block.
3. Fix the power connection cable with cord anchorage, (for cooling and heating unit, use the cord anchorage to fix the power connection cable and the signal control wire).
4. Ensure wire has been fixed well.
5. Install the handle.

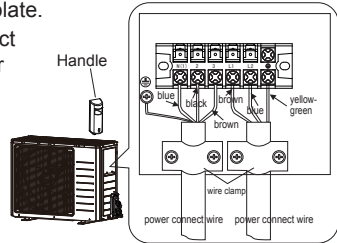

NOTE:

- Wrong wiring may cause spare parts malfunction.
- After the cable fixed, make sure there should be a free space between the connection and connection and fixing place on the lead wire.
- The connecting wire and connection pipe cannot touch each other.
- Top cover of outdoor unit and electric box assembly should be fixed by the screw. Otherwise, it can cause a fire, or short circuit caused by water or dust.

Install the over line pipe

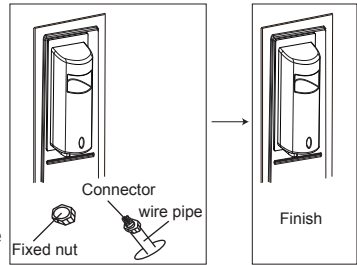

Air purging and leakage test

1. Connect charging hose of manifold valve to charge end of low pressure valve (both high/low pressure valves must be tightly shut).
2. Connect joint of charging hose to vacuum pump.
3. Fully open handle handle of Lo manifold valve.
4. Open the vacuum pump to evacuate. At the beginning, slightly loosen joint nut of low pressure valve to check if there is air coming inside. (If noise of vacuum pump has been changed, the reading of multimeter is 0) Then tighten the nut.
5. Keep evacuating for more than 15mins and make sure the reading of multi-meter is -1.0×10^5 pa (-76cmHg).
6. Fully open high/low pressure valves.
7. Remove charging hose from charging end of low pressure valve.
8. Tighten bonnet of low-pressure valve. (As shown in Fig.10)

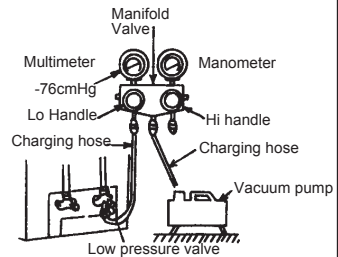
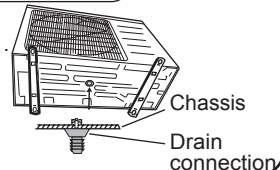

Fig.9

Condensate drainage of outdoor unit (no for cooling only)

The condensate and defrosting water formed during heating in the outdoor unit can be properly discharged by drainage pipe. Installation method: set the drain connection in $\varnothing 25$ hole of the chassis has been installed and then connect drainage pipe with drain nozzle, so that condensate and defrosting water can be properly discharged.



◆ Check after installation and test operation

Check after installation

Items to be checked	Possible malfunction
Has it been fixed firmly?	The unit may drop, shake or emit noise.
Have you done the refrigerant leakage test?	It may cause insufficient cooling(heating) capacity
Is heat insulation sufficient?	It may cause condensation and dripping.
Is water drainage well?	It may cause condensation and dripping.
Is the voltage in accordance with the rated voltage marked on the nameplate?	It may cause electric malfunction or damage the part.
Is the electric wiring and piping connection installed correctly and securely?	It may cause electric malfunction or damage the part.
Has the unit been connected to a secure earth connection?	It may cause electrical leakage.
Is the power cord specified?	It may cause electric malfunction or damage the part.
Is the inlet and outlet been covered?	It may cause insufficient cooling(heating) capacity.
Has the length of connection pipes and refrigerant capacity been recorded?	The refrigerant capacity is not accurate.

Test Operation

1. Before test operation

- (1) Do not switch on power before installation is finished completely.
- (2) Electric wiring must be connected correctly and securely.
- (3) Cut-off valves of the connection pipes should be opened.
- (4) All the impurities such as scraps and thrums must be cleared from the unit.

2. Test operation method

- (1) Switch on power, press "ON/OFF" button on the wireless remote control to start the operation.
- (2) Press MODE button, to select the COOL, HEAT (Cooling only unit is not available), FAN to check whether the operation is normal or not.

◆ Installation and Maintenance of Healthy Filter

Installation Instructions

1. Forcibly pull the panel for a specific angle from the two ends of the front panel according to the arrow direction. Then pull the air filter downwards to remove it. (See Fig.a)

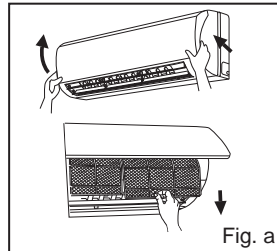

2. Mount the healthy filter onto the air filter, (as shown in Fig.b). If the air filter cannot be installed, please mount the healthy filter on the front case. (as shown in Fig.c)

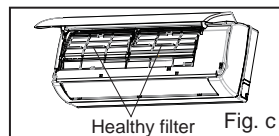
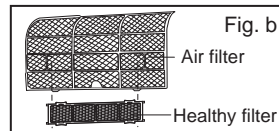

3. Mount the air filter properly along the arrow direction in Fig.d, and then close the panel cover.

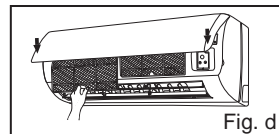

Cleaning and Maintenance

Take out the healthy filter before cleaning and reinstall it after cleaning according to the installation instruction. Pay special attention to that silver ion filter can't be cleaned with water, while active carbon, photocatalyst, low temperature conversion (LTC) catalyst, formaldehyde eliminator, catechin or mite killing filter can, but can't with brush or hard things. Dry it in the shade or sun after cleaning, but not by wiping.

Service Life

The healthy filter commonly has its usage lifetime for one year under normal condition. As for silver ion filter, it is invalid when its surface becomes black (green).

- This supplementary instruction is provided for reference to the unit with healthy filter. If the graphics provided herein is different from the physical goods, the latter one shall prevail. The quantity of healthy filters shall be based on the actual delivery.

